

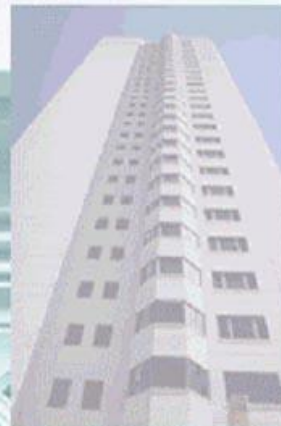

GUIDE TO THE MANUFACTURE OF GRC PRODUCTS

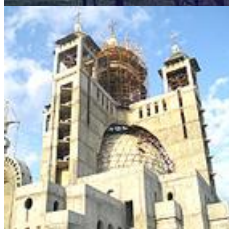

POWER-SPRAYS & FIBRE TECHNOLOGIES

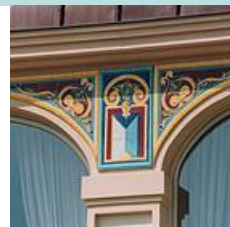

GUIDE TO THE MANUFACTURE OF GRC PRODUCTS

INTRODUCTION

Glass Reinforced Concrete, GRC, sometimes referred to as GFRC, Glass Fibre Reinforced Concrete is a cement sand matrix reinforced with an alkali resistant glass fibre. The resulting composite inherits valuable tensile strength from the glass fibre.

GRC is a very versatile construction material allowing strong, tough yet lightweight products to be manufactured.

Common GRC products are:

- Architectural components,
- Architectural and industrial cladding,
- Prefabricated buildings,
- Sunscreens,
- Artificial rocks,
- Noise barriers,
- Ducts and channels,
- Agricultural products,
- Sewer linings,
- Permanent formwork,
- Street furniture,
- Utility boxes,
- Renders

METHODS OF MANUFACTURE

There are two basic methods of production in common usage worldwide. These are the Spray and the Premix Processes.

Certain products are more suited to the Spray Process and others to Premix.

Many manufacturers would use both methods.

With Sprayed GRC, a cementitious slurry and chopped Glassfibres are simultaneously sprayed onto moulds using a special spray gun that also chops the fibre.



The Spray Gun can be Hand Held (Hand Spray) or mounted on an Auto-Traverse (Auto or Machine spray).



In Premix GRC, chopped Glassfibre is added to the cementitious slurry during mixing. The mixed material can then be poured or pumped into moulds using vibration (Vibration Cast Premix) or without vibration using a special Self Compacting additive. It can also be sprayed directly onto moulds (Sprayed Premix).

PRODUCTION METHODS FOR GRC PRODUCTS



Raw Materials



AR Fibre Chopped Strands

Mixing



AR Fibre Roving



Spraying



Sprayed Premix



Spraying

PREMIX GRC



SPRAYED GRC

GUIDE TO THE MANUFACTURE OF GRC PRODUCTS

CONTENTS

SECTION 1. REQUIREMENTS FOR GRC PRODUCTION	<i>PAGE 05</i>
SECTION 2. BASIC PROCEDURE FOR THE MANUFACTURE OF GRC PRODUCTS	<i>PAGE 19</i>
SECTION 3. EXAMPLES	<i>PAGE 50</i>
SECTION 4. APPENDIX	<i>PAGE 61</i>

SECTION 1. REQUIREMENTS FOR GRC PRODUCTION

FACTORY	PAGE 07
Services Layout & Waste disposal	
PRODUCTION EQUIPMENT	PAGE 11
Hand-Spray GRC Premix GRC Weighing / Dispensing Ancillary Equipment	
QUALITY CONTROL AND TESTING EQUIPMENT	PAGE 14
Balance Oven / Wire Baskets Slump test kit Flexural testing machine	
PRODUCT HANDLING	PAGE 15
Overhead Crane Fork lift truck	
MOULDS	PAGE 15
Steel Timber GRP Rubber Other	
MATERIALS	PAGE 16
Cement Sand/Aggregate Glass Fibre Water Admixtures Polymers Pigments Mould Release Agents Other	

REQUIREMENTS FOR GRC PRODUCTION

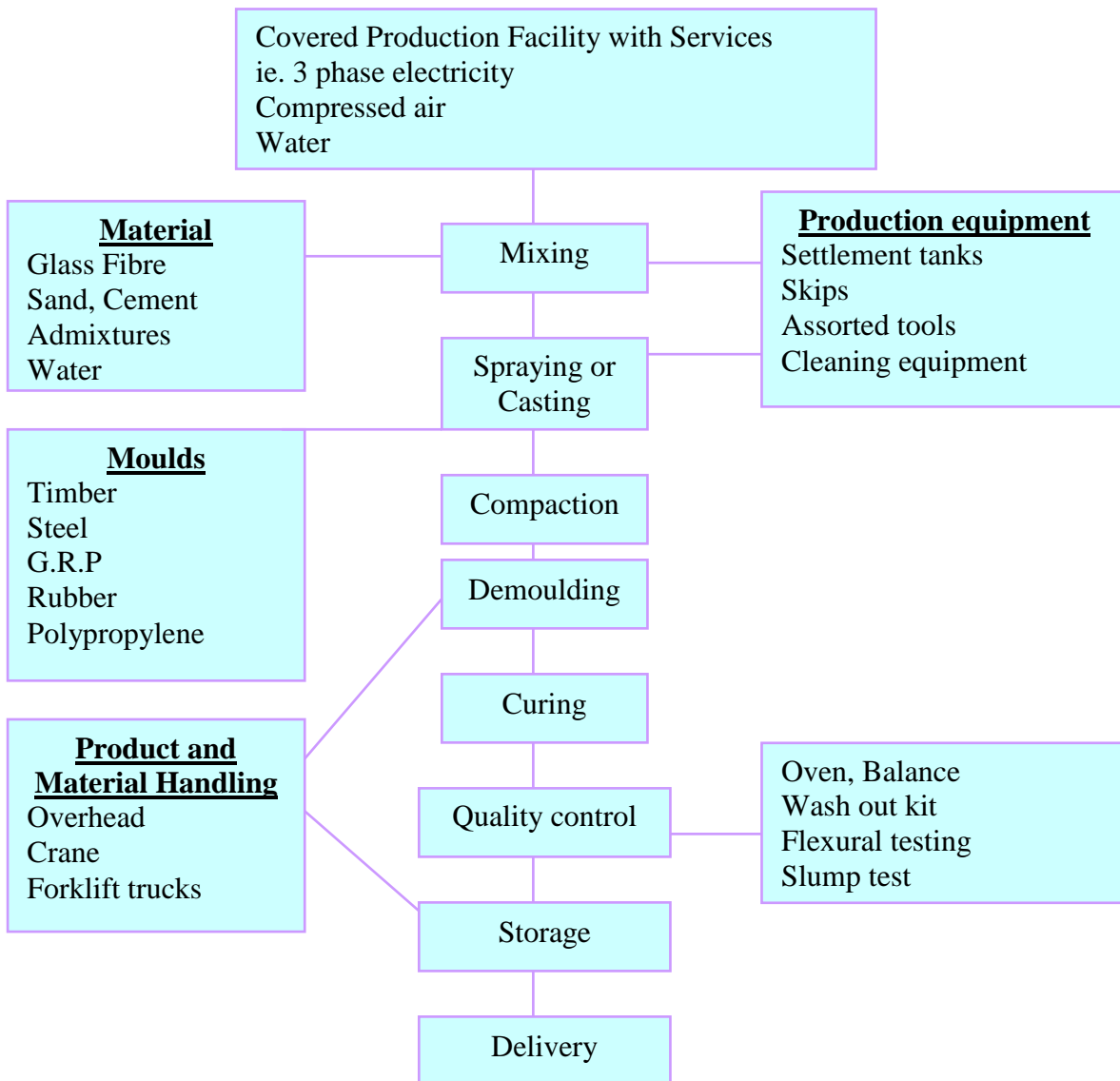

FACTORY

GRC should be manufactured in a covered factory rather than on site. It should be possible to maintain a minimum temperature of 10°C with a temperature range of 15 - 30°C being ideal.

The size of the factory will depend upon the output required with the minimum recommended covered area being 200m². In addition to this, there must be an uncovered area approximately 4 times this for product storage and finishing operations. There should be an area in the factory set aside for washing / cleaning the equipment and another for moist curing of the products.

SERVICES

GRC production equipment requires a 3 phase electric supply typical 50KvA and compressed air supply minimum 100psi/7bar 50CFM/1500 litres per minute per spray station. In practice a 100 CFM / 3000 litres/minute compressor or larger would be bought in order to allow for future expansion.

LAYOUT & WASTE DISPOSAL

There is a wide range of possible factory layouts but these fall into two main types:
The position of the equipment can be fixed with the moulds being moved or the moulds can be fixed and the equipment can move.

Both systems are shown schematically.

OPTION A - Fixed Equipment, Movable Moulds

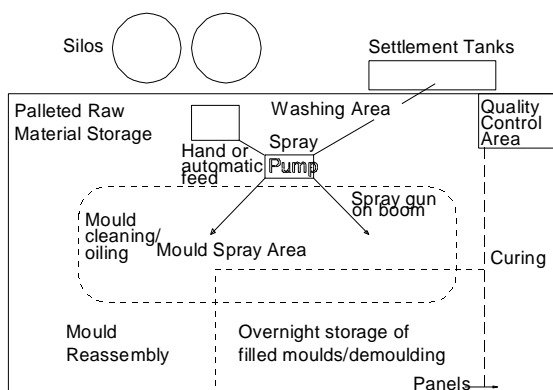

ADVANTAGES:

1. Spraying takes place in a specific area making factory cleaning easier.
2. Overhead spray boom can be used.
3. Easier to automate.

OPTION B - Fixed Moulds, Movable Equipment

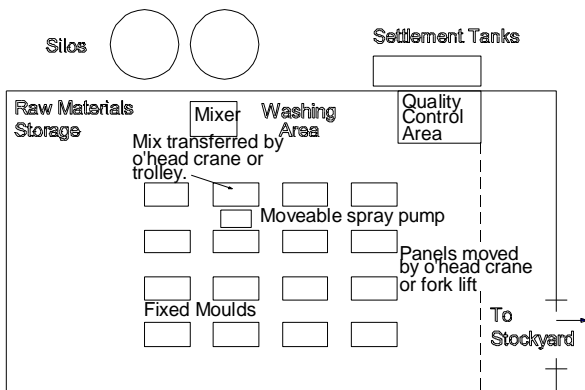

ADVANTAGES:

- 1) Moulds can be rigidly fixed on level beds.
- 2) Flexibility; any size of mould can be accommodated.
- 3) Additional spray pumps may be added to increase output.

Whichever system is used there should be areas allowed for storage of raw materials, mould manufacture and repair, finishing of products and moist curing of products.

There should be an area for washing the equipment and facilities for the collection / recycling and disposal of wastewater and solid wastes.

Settling pits can be used to collect the wastewater that could be reused for cleaning. The settling pits must be regularly dug out and the solids disposed of in accordance with local regulations.

Typical GRC Factory Layout

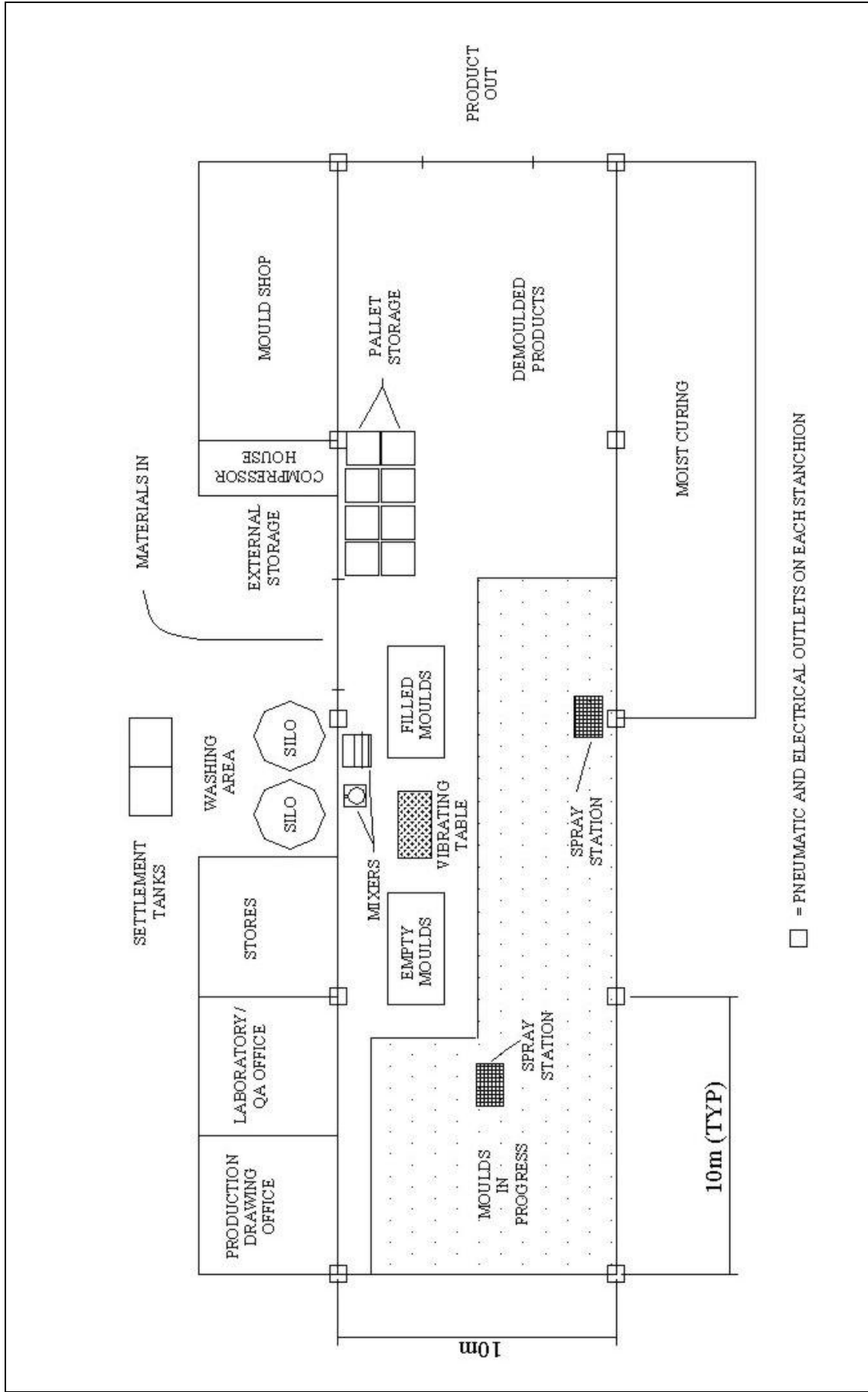

Typical GRC Site Layout

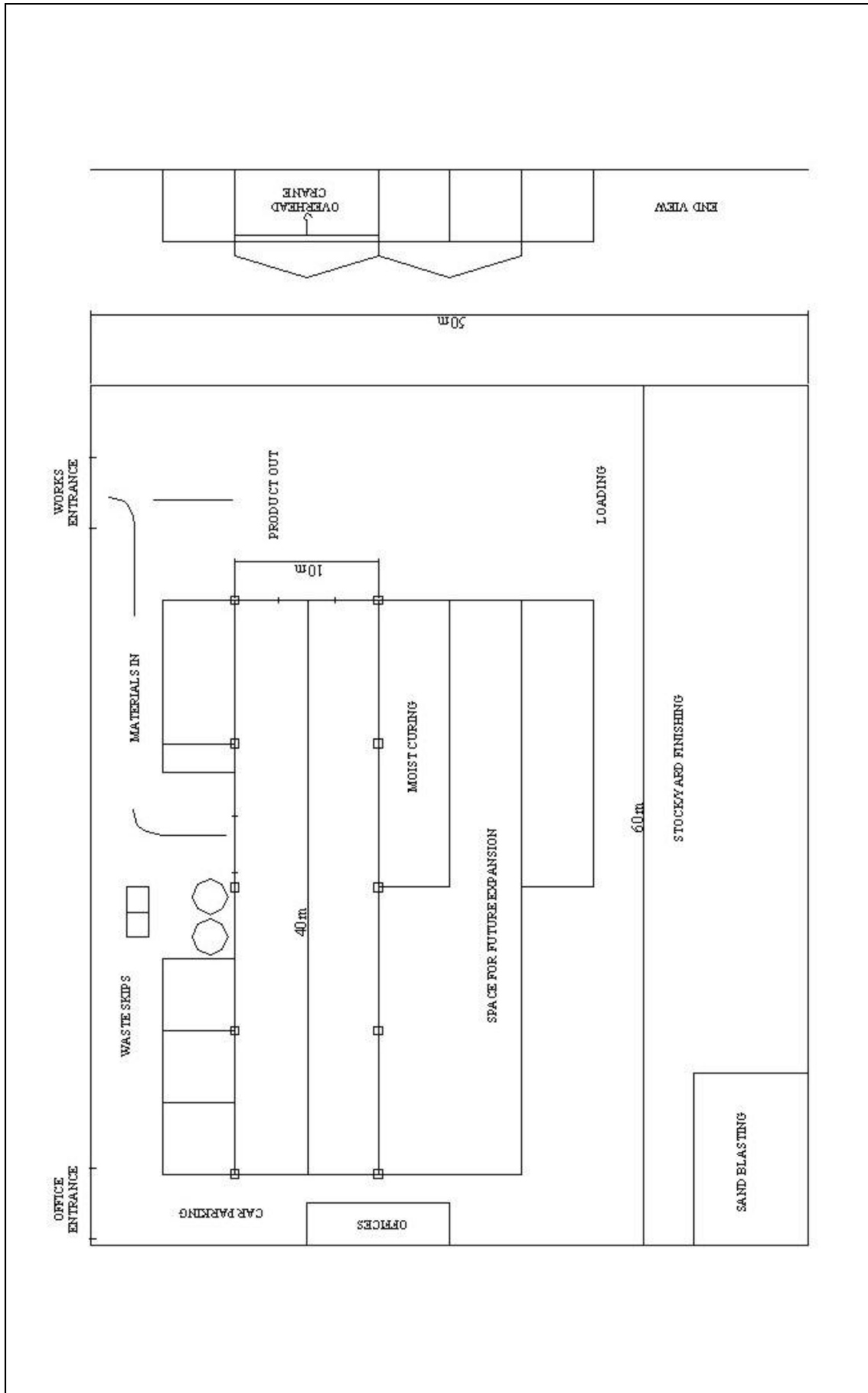

PRODUCTION EQUIPMENT

The manufacture of GRC products requires specialist equipment that differs depending upon the production method chosen.

HAND-SPRAYED GRC

High Shear Mixer – GRC 125 – GRC125S Combination Mixer – GRC 125 Combination

Due to the nature of the GRC mix concrete or mortar mixers are not suitable.

A High Shear or Combination Mixer is required to produce high quality slurry at low water cement ratios. The mixer can be a hand fed manual version or it can be automated and fitted with liquids and material batching systems.



GRC125-1 High Shear Mixer



GRC125 Combination Mixer

Spray Station – PS9000 – PS10000

After mixing the slurry is transferred to a spray station. This comprises a Pump and a Concentric Spray Gun. The slurry is pumped to the Spray Gun where it is atomised and sprayed together with glassfibre which is chopped in the Spray Gun.

As the name suggests in the Hand Spray process, the gun is moved by Hand. The gun can also be mounted on a reciprocating traverse – Auto-Spray or even on a programmable robot.



PS9000A GRC Spray Station



MK3 Facing Coat Spray Gun



Concentric Spray Gun



Slump Test Kit



Spring Rollers



Water Polymer & Admixture Dispenser

PREMIX GRC

Mixing – GRC 125 Combination Mixer

A two-stage mixing method is required. First a High Shear Mixer action as for Hand-Spray and then a more gentle action is required to blend in the fibre. If the fibre is added to a High Shear Mixer then the strand can break into filaments and the mix would lose workability.

The GRC 125 Combination with its triple helix blade and variable speed 0-1400rpm mixes both the high shear slurry at high speed and blends in the fibre at low speed. It can therefore be used for both processes without compromise.



GRC125-1 High Shear Mixer



Vibrating Table
2.4 x 1.2m or 1.2 x 1.2m
available

Vibration Casting

When casting (i.e. mould filling) vibration helps the flow of the GRC and removes air.

Vibration Tables have been found to be the best method of producing the necessary vibration.

Sprayed Premix

The Premixed GRC can also be sprayed using a PS38 Pump Spray Station. These differ from the Hand-Spray equipment, which cannot be used to pump and spray premix.



PS38A Combination Spray Station



Single Roving Chopper



Water Polymer & Admixture Dispenser



GRC125S Combi Mixer

The choice of production method and equipment may appear confusing. However, if the type of products to be made is known, Power-Sprays and Fibre Technologies International can advise on the most suitable method.

WEIGHING / DISPENSING

The mix quantities should be accurately measured.

The liquids – water, admixture, and polymer – can be measured by volume and the dry ingredients - cement & sand – should be weighed or purchased in preweighed quantities.

A liquid dispensing system not only ensures accuracy but also reduces waste.

A scale with a capacity of 100 kgs with an accuracy of 20 g would be ideal for weighing the dry materials.

ANCILLIARY EQUIPMENT

The following ancillary equipment is essential:

- Hand Trowels / floats
- Compaction rollers
- Thickness gauges
- Pressure washer



Large 'NT' Type Spring
Compaction Roller
Spring section 14cm x 4cm Ø



Extra Long 'T' Type Spring
Compaction Roller
Spring section 17cm x 4cm Ø



Small 'T' Type Spring
Compaction Roller
Spring section 9.5cm x 2.5cm Ø



Large 'T' Type Spring
Compaction Roller
Spring section 14cm x 4cm Ø

QC / QA EQUIPMENT

For the manufacture of Quality Assured GRC products it is necessary to have or have access to the following equipment.

BALANCE

Capable of weighing 1000 gms in increments of 0.1 gm.

MUFFLE FURNACE

Temperature 500 °C and/or an oven with forced air circulation capable of maintaining a temperature of 105 ± 5 °C, together with sample baskets.

SLUMP TEST KIT



This is a proprietary "kit" which can be obtained from Power-Sprays Ltd.

FLEXURAL TESTING MACHINE

The most important QC test for GRC is the Flexural test described in BS6432, EN1170 parts 4&5 and the GRCA Methods of Test.

Flexural Test Machines using X Y plotters or chart recorders are now obsolete and modern machines are fitted with PC interfaces.



Typical Flexural Testing Machine.

Fibre Technologies International can arrange to undertake this testing for customers.

PRODUCT HANDLING

Although considerably lighter than equivalent concrete components many large GRC items are too heavy to lift by hand and it is therefore necessary to consider some form of mechanical handling.

OVERHEAD CRANES

These are ideal for the movement of products within the factory. They maximise the use of factory space by allowing moulds to be closely spaced.

FORKLIFT TRUCKS

Ideal for use in the stockyard and for loading and unloading. They can be used internally for demoulding and product handling, but the necessary driveways reduce the effective area of the factory.

MOULDS

Moulds can be manufactured from a variety of materials. Whichever material is chosen the mould must, for the number of casts required, maintain dimensional accuracy and the required surface finish. Common mould materials are:

STEEL

Used for standard and other products where large numbers of casts are involved.

TIMBER

Probably the most widely used and versatile material.

GRP

Used when more than one mould of a particular shape is required.

RUBBER

Many intricate shapes cannot be satisfactorily manufactured from a rigid mould and in these cases flexible moulds must be used.

These are relatively simple to manufacture using Duramould a 2 part polyurethane rubber. Instructions on how to manufacture a flexible mould can be found at www.fibretech.org

OTHER

The above list is not exhaustive and many other materials including polypropylene, plaster and GRC itself have been used successfully.

MATERIALS

The basic raw materials for GRC production are: Cement, sand, water and alkali resistant glass fibre. To these basic materials, admixtures, polymers, pigments and other additives may be used to achieve particular properties.

CEMENT

Cement suitable for precast concrete production is generally suitable for GRC. The choice of which Portland Cement type, ie. OPC, RHPC, SRC or White Cement is dictated by the end product, and the choice of supplier by economic as well as technical considerations. The cement used must comply with Local Statutory Regulations - eg. UK BS197-1 and USA ASTM C150.

SAND / AGGREGATE

The choice of sand/aggregate henceforth referred to as sand is very important for the production of good quality GRC. The sand must be hard, durable and clean and should be suitably graded.

For hand-spray process the maximum particle size should be 1.2mm. The fine fraction, ie that below 150 microns should not exceed 10%.

For Premix, the maximum particle size is not so important but the other properties should be maintained.

Silica sands have been used extensively in GRC production and a typical specification would be:

Silica Content	> 96 %	GRADING
Moisture	< 2 %	a) Max 1.2mm ie. 100% passing
Soluble Salts	< 1 %	BSS14
Loss on ignition	< 0.5 %	b) Fine fraction
Sulphate	< 0.4 %	Max 10% passing 150 microns BSS 100
Chloride	< 0.6 %	

However many sands outside this specification may be suitable for GRC production. Crushed and graded aggregates particularly marble, limestone, and granites are known to be satisfactory. Dried sands will make control of the mixing process easier and it is usual to buy and store sand dried, either in bags or in bulk silos. Soft sands often referred to as builders sand are not regarded as suitable for GRC production

GLASS FIBRE

Glass fibre must be of an alkali resistant type specifically formulated for use in GRC. The best Alkali Resistant Glassfibre with the highest zirconia content is manufactured by NEG and is available from Fibre Technologies International Ltd.

There are several forms, but the most widely used are:

Spray Process: Supplied as Roving

- AR2500H103 The most widely used AR Fibre.
It is particularly suitable for architectural products.
- AR2500H200 This is a stiffer fibre used for Hand and Auto-Spray
Particularly suited to large flat products
- AR2500H350Y Can be used at lower fibre percentages for certain products
AR5000H350Y

Premix Process: Supplied as Chopped Strands

- ACS13H530X General Premix fibre suitable for all applications.
ACS25H530X
- ACS9H350Y Premix fibres particularly effective at low fibre percentages
ACS13H350Y
- ACS13PH901X Can be used at higher percentages with minimum
ACS25PH901X effect on workability.
These fibres are particularly suitable for Sprayed Premix

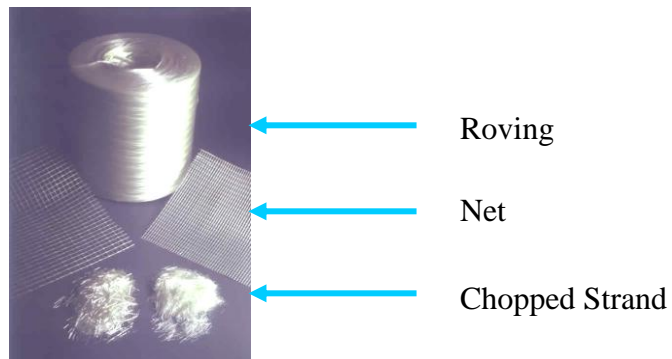

It is recommended that individual GRC manufacturers consult Fibre Technologies International who will advise on the most suitable fibre type for their particular application.

WATER

Water suitable for concrete is suitable for GRC. In extreme climatic conditions either heating or cooling of the water may be necessary.

ADMIXTURES

These are widely used in the manufacture of GRC to assist in the manufacturing process and to enhance the final properties. A plasticiser should be used to maintain workability whilst allowing reduction in the water cement ratio. Admixtures can also accelerate, retard, reduce bleeding, waterproof and reduce segregation. The selection of the most appropriate will depend on local factors, particularly the cement and sand used and the climatic conditions.

POLYMERS

Cementitious products should be moist cured to ensure that there is sufficient retained moisture for complete hydration of the cement. This is particularly critical for thin skin GRC products. The recommended curing regime is a wet cure at 95% relative humidity for 7 days. In many cases this is not practical as insufficient factory space is available.

When an acrylic polymer is added to the mix at the recommended dosage it forms a film within the matrix during the first few hours of curing. The formation of this film significantly reduces the permeability and thus lessens the loss of water by evaporation ensuring that sufficient water is available for complete hydration.

The polymer has other benefits particularly the reduction or elimination of surface crazing on architectural products.

PIGMENTS

Pigments can be used to colour either white or grey cement. To achieve consistency their use is often associated with a "facing mix" which subsequently receives post treatment normally acid washing, sand blasting or polishing.

MOULD RELEASE AGENTS

All moulds require a thin coat of release agent daily prior to use.

OTHERS

The above list has considered commonly used materials but individual manufacturers can gain economic or technical advantages by the use of other materials, eg fast setting cement, low alkali cements, PFAs, micro-silicas.

Fibre Technologies International would be happy to advise on the suitability of local raw materials.

SECTION 2. BASIC PROCEDURE FOR THE MANUFACTURE OF GRC PRODUCTS

WHICH PRODUCTION METHOD?	PAGE 21
MIXING	PAGE 21
Mix design	
Glass content	
Typical mix design	
Weighing / batching	
Mixing procedures	
Slump test	
MOULDS	PAGE 28
SPRAYING	PAGE 29
Calibration, bag and bucket test	
Mist coat	
Facing coat	
Spraying	
Compaction	
Spraying of test board	
Placing of ribs, sockets, stud frames	
CASTING	
Vibration	
Self Compacting Premix	
Mould Filling	
Sample board	
Storage prior to demoulding	
Cleaning	
DEMOULDING AND HANDLING	PAGE 36
When to demould	
Methods of demoulding	
Handling	
CURING	PAGE 37
FINISHING – STORAGE	PAGE 38
QUALITY CONTROL TESTING	PAGE 39
Introduction	
Determination of glass content	
Determination of flexural strength	
Determination of dry and wet bulk density, water absorption and apparent porosity	

BASIC PROCEDURES FOR THE MANUFACTURE OF GRC

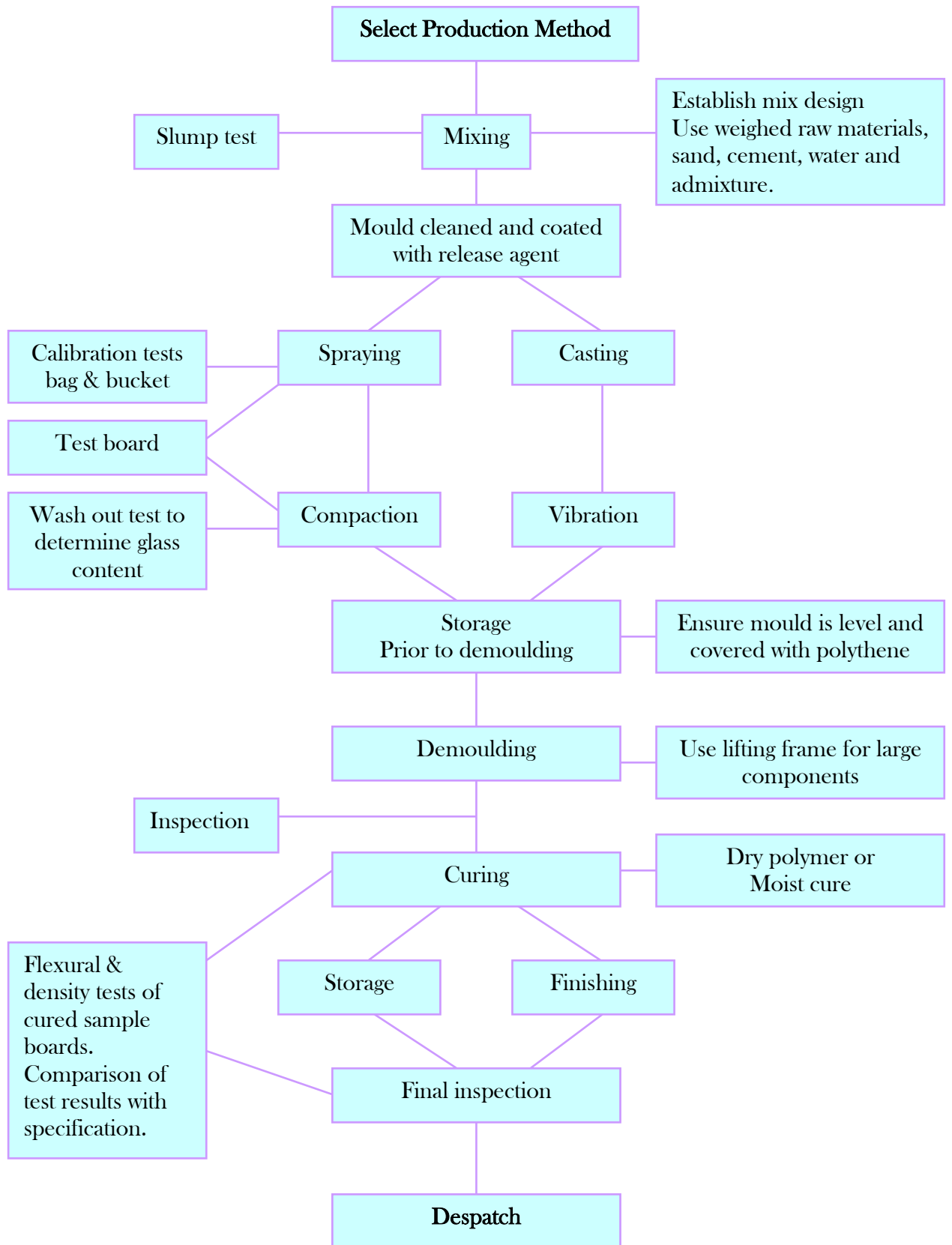

WHICH PRODUCTION METHOD?

The type of product usually dictates the method of production.

Large architectural cladding panels are normally sprayed whilst smaller decorative elements may be premixed. Some products may be produced by either method.

However, the mechanical properties of GRC produced by the different production methods varies and this must be considered in the product design. A sprayed product may have a 12 mm thickness whilst a similar product in premix may require 14-15 mm.

Premix moulds are more costly than sprayed moulds but the premix process is easier to automate. Thus for long production runs of standard products, premix would be preferred but for small numbers hand spray would be the more economic option.

MIXING

MIX DESIGN

Selecting the correct mix design is essential in making quality GRC products.

The GRC mix chosen must achieve the required mechanical properties at 7 & 28 days. It must have achieved sufficient strength for demoulding and must have the required workability and maintain this workability during the production process.

A basic GRC mix consists of Portland cement, fine sand, water, plasticizer and/or polymer.

It is now normal practice to use equal quantities of sand and cement – ie a 1:1 Sand/Cement ratio. The sand is essential to reduce shrinkage in the GRC.

The Water/Cement ratio should be as low as possible - normally in the range 0.30 – 0.38. To achieve this it is necessary to add plasticizers or super plasticizers to the mix. Depending on the climatic conditions retarding or accelerating plasticizers should be used.

The dosage rates of plasticizers vary enormously and the manufacturers recommendations should be used. Dosage rates are normally quoted as % addition by weight of cement.

The Water/Cement ratio refers to the total weight of water in the mix not just the added water. Water can also be present in the sand and in any added polymer. If 50 kgs of sand are added and the sand had a 6% moisture content then 3 kgs of water is contained in the sand and this must be removed from the added water.

When polymer is added, the addition rate is measured as weight of polymer solids by weight of cement. Polymer is supplied as an emulsion (solids in water) - often 50% solids. For 50 kgs of cement, 5% polymer solids is 2.5 kgs of solid or 5.0 kgs of emulsion. When calculating the added water in a polymer mix, the water in the polymer should be allowed for.

The above may seem complicated but once a mix has been established, it should be used daily and with only minor changes to suit changes in temperature or raw materials.

GLASS CONTENT

The glass content is the percentage of glassfibre measured as a percentage of the total weight.

ie:
$$\text{Glassfibre \%} = \frac{\text{Weight of Glass}}{\text{Weight of Glass} + \text{Weight of Cementitious Slurry}}$$

For the Spray Process the glassfibre percentage would be in the range 4 – 5% and for Premix 1.5 – 3.5%.

In Premix, the glass is added to the mix and so the weight of glass is shown as a component of the mix.

In the Spray Process were the fibre and cementitious slurry are fed independently to the Spray Gun, then a fibre percentage is normally stated.

With Premix the fibre length typically 13 mm would be stated, with Hand-Spray glassfibre roving is used and the fibre length is dictated by the number of cutting blades in the spray gun.

TYPICAL MIX DESIGN

Hand-Spray (Non Polymer)

QUANTITIES (kgs)		RATIOS	
Cement (OPC)	50.0	Cement/Sand ratio	1:1
Sand	50.0		
Water	16-17	Water/Cement ratio	0.32 – 0.34
Superplasticizer	250 ml	Plasticizer	0.5% on cement
Sprayed with 5% Glassfibre AR2500H103			

Hand-Spray (Polymer)

QUANTITIES (kgs)		RATIOS	
Cement (OPC)	50.0	Cement/Sand ratio	1:1
Sand	50.0		
Water	13-14	Water/Cement ratio	0.31 – 0.33
Acrylic Polymer (50% solids)	5.00		(14.0 Added Water, 2.5 in Polymer)
Superplasticizer	125 ml	Plasticizer	0.25% on cement
Sprayed with 5% Glassfibre AR2500H103			

Premix (Non Polymer) For Vibration Cast

QUANTITIES (kgs)		RATIOS	
Cement (OPC)	50.0	Cement/Sand ratio	1:1
Sand	50.0		
Water	16.0	Water/Cement ratio	0.32
Superplasticizer	500 ml	Plasticizer	1.0% on cement
Glassfibre	3.0 kg		
Content: 2.5% Glassfibre ACS13H530X			

Premix (Non Polymer) Self Compacting

QUANTITIES (kgs)		RATIOS	
Cement (OPC)	50.0	Cement/Sand ratio	1:1
Sand	50.0		
Water	18.0	Water/Cement ratio	0.32
Flowaid SCC	500 ml	Flowaid SCC	1.0% on cement
Glassfibre	3.0 kg		
Content: 2.5% Glassfibre ACS13H530X			

Premix (for Premix Spray)

QUANTITIES (kgs)		RATIOS	
Cement (OPC)	50.0	Cement/Sand ratio	1:1
Sand	50.0		
Water	13.5	Water/Cement ratio	0.32
Acrylic Polymer	5.00	5% Polymer Solids on Cement	
Pumpaid FT	250 ml	Special additive to assist pumping	
Superplasticizer	125 ml		
Glassfibre	3.68 kg		
Fibre Type ACS13PH901X. This fibre is recommended for Sprayed Premix applications			

The specialist raw materials, plasticizers, polymers, pumpaids and glassfibre can all be supplied by Fibre Technologies International Ltd

WEIGHING / BATCHING

Once a mix design has been established it should be adhered to. The only way to ensure uniformity is to accurately weigh the raw materials and to be consistent in the method of operation of the mixer.

All raw materials in the factory should be clearly marked so that they can be really identified and compared to the specified material.

The dry materials – cement and sand – should be weighed. When they are supplied in bags of known weight, then one bag could be added provided the bags are of consistent weight.

Liquids should be added by volume and consistency is critical. The most common fault in GRC production is adding the wrong quantity of water. A volumetric measuring and dispensing system can be used for water, polymer and plasticizer.



Water Polymer & Admixture Dispenser

When chopped glassfibre is added, it must be weighed. It is not possible to batch by volume. A bucket full of fibre will vary dramatically depending on how much it is compacted. The best method is to accurately weigh the glassfibre into polythene bags and then add 1 bag per mix.

In automated systems. The glassfibre can be chopped directly into the mixer and a timer, or a loss in weight system can be used.

Alternatively chopped glass fibre can be accurately dispensed using the “Chopped Fibre Feeder”



Multi-roving chopper



Chopped Fibre Feeder

MIXING PROCEDURES

Mixing For Spray Production

A typical method of mixing using the GRC125 High Shear Mixer is:

1. With mixing tub in position lower mixer and press “start”;
2. Add water and other liquids;
3. Add sand;
4. Keep the mixer running and add cement;
5. After all the cement has been added, mix for a further 15 seconds;
6. Stop and raise mixer, clean blade and scrape any unmixed material from the side of mixing tub;
7. Lower mixer and mix for a further 10 seconds;
8. The mix is now ready for use and should be poured into the pump hopper through a vibrating sieve, The sieve size is chosen to remove any lumps from the mix which may subsequently block the spray gun.



GRC125-1 High Shear Mixer

Notes

- a. Before the first mix of the day wet the mixing tub and blade. This will ensure that the first mix is not too stiff.
- b. The mixing action requires that the tub and blade are kept clean.
- a. For consistency a dispensing system should be used for water and additive.
- d. When mixing using polymers a false set may occur immediately after the end of the mixing cycle. This can be mixed out by mixing on fast for a further 10 seconds. Extra water or plasticiser may be required.

Mixing For Premix Production

A typical method of mixing premix is using the GRC 125 Combination Mixer:

1. Raise the mixer and pour in measured quantities of water and other liquids; Lower the mixer and start on slow speed 2-3
 2. Add sand;
 3. Add cement;
 4. Increase the mixer speed to fast. 6-7.and continue mixing for 20-40 seconds.
 5. Stop the mixer and raise it. Clean any build up from the sides of the drum and assess the workability. If necessary add further materials.
 6. Restart the mixer and mix on fast speed for 10-20 seconds.
 7. Reduce the mixer speed to slow. Add the glassfibre strands from a preweighed batch evenly and quickly through the loading chute.
 8. When all the fibres have been added, continue mixing briefly (10 seconds);
 9. Stop the mixer and raise. The plastic tub containing the mix can now be removed
- OVERMIXING, USING THE WRONG TYPE OF MIXER OR USING THE WRONG TYPE OF FIBRE WILL CAUSE POOR QUALITY GRC DUE TO THE FILAMENTIZATION OF THE FIBRE.**



GRC125 Combination Mixer

SLUMP TEST

After mixing the consistency of the mix can be checked by a simple slump test:

Apparatus (*Obtainable from Power-Sprays Ltd*)

1. Tube
2. Plexiglas Target Plate
3. Spatula

Procedure

1. Place tube centrally on the target plate
2. Fill with slurry*, if necessary air bubbles are expelled by gently rodding the mix.
3. Screed the slurry top and level with the edge of the spatula. Clean any excess slurry from the plate with a damp cloth.
4. Lift the tube vertically off the plate with a slow continuous motion allowing the slurry to flow over the target area of concentric circle.
5. Measure the slump by the number of rings covered by the slurry. Given standard formulations 2 to 3 rings is the normal range to be aimed for depending on the relevant ambient temperatures.

* For Premix, test the slurry before the addition of fibres.

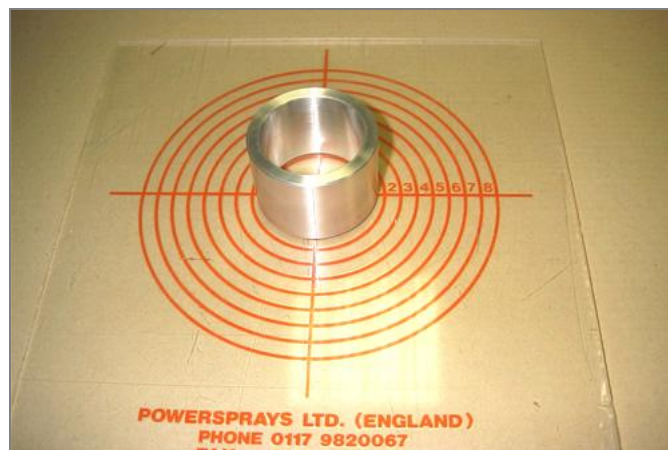

SLUMP TEST

1.

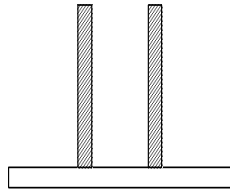

Place tube centrally onto Plexiglas target plate.

2.

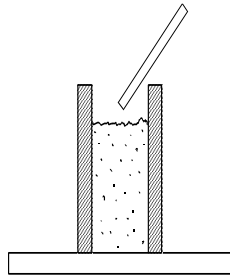

Fill tube with slurry, gently rodding to remove air bubbles.

3.

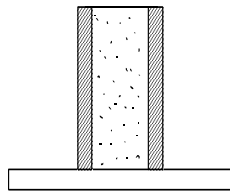

Level off top of slurry.

4.

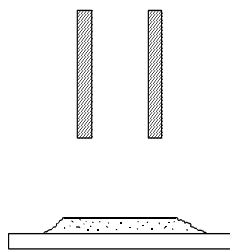

Remove tube vertically allowing the slurry to flow over the target area of concentric circles.

5.

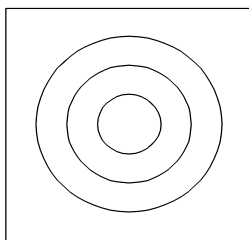

Measure the number of rings covered

MOULDS

Prior to starting manufacture, a sufficient number of moulds should be 'ready' so as to ensure continuous production. Start/Stop production should be avoided at all costs particularly in the spray process where prolonged stops will mean additional pump washouts.

A daily mould preparation sequence would involve:

Assembly

Reassemble the moulds ensuring all sides, ends, block outs, etc are in the right position. Check that there are no gaps and 90° degree corners are square. Visually check that there has been no deterioration which would affect the final product and check key dimensions with a tape.

Cleaning

Thoroughly clean the mould and remove any loose debris.

Release agent

Apply a thin coat of release agent to all mould surfaces by cloth, brush or spray.

Remove any excess with a cloth.

(Suitable release agents are widely available)

Inspection

After a final inspection the mould is ready for production.

SPRAYING

Spraying is carried out by teams normally consisting of 3 - 6 people. They should be familiar with the procedure of operation, cleaning and maintenance of the equipment provided by the manufacturer.



PS9000A GRC Spray Station



Spraying with a Concentric Spray Gun

CALIBRATION, BAG AND BUCKET TEST

Prior to production the equipment should be "calibrated" to ensure that the outputs of slurry and chopped glass fibre are consistent with the required glass percentage. The calibration is carried out by using 2 simple tests, known as the Bag and Bucket tests. The test method and typical calibration chart are attached. Once calibration is complete spraying can start.

BAG AND BUCKET CALIBRATION TABLE

For 5%

Glass Output		Slurry Output	
g/15 sec	kg/min	kg/30 sec	kg/min
132.0	0.526	5.00	10.00
145.0	0.580	5.50	11.00
*158.0	0.631	6.00	12.00
171.0	0.684	6.50	13.00
184.0	0.737	7.00	14.00
197.0	0.789	7.50	15.00

*Normal Output for concentric Gun

BAG TEST

The object of this test is to measure the output of glass fibre.

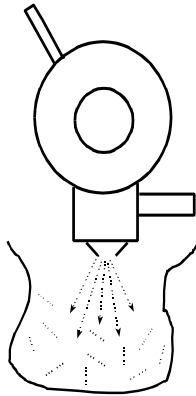

- a) Weigh bag empty - (M) g.
- b) Chop glass into bag for 15 seconds.
- c) Weigh bag with fibre - (T) g.
- d) Calculate output of glass from $(T - M) \times 4 \text{ g/min}$.
- e) Adjust air to chopper motor to achieve required output.

BUCKET TEST

The object of this test is to measure the output from the slurry spray.

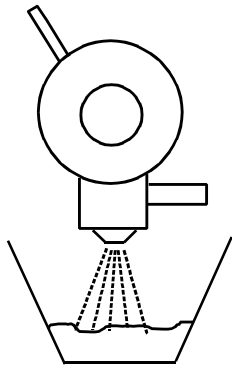

- a) Weigh the bucket empty (M) Kg
- b) Spray the slurry into the bucket for 30 seconds
- c) Weigh the bucket with the slurry (D) Kg
- d) Calculate the output of the slurry pump from $(D-M) \times 2\text{Kg/min}$
- e) Adjust the pump output until required rate is achieved

QUALITY CONTROL TEST RECORD

GLASS CONTENT

DATE.....

BAG AND BUCKET TEST

Team No.	Glass Output per 15 secs. Glass Output x 2 = per 30 secs.	Slurry Output per 30 secs.	Glass Content %

MIST COAT

With the Air Mover Pressure turned up to 50 psi and with the operator blocking the empty glass tube with his thumb a fine mist coat can be sprayed onto the mould. This mist coat should be between 0.5 and 1.0 mm thick and care should be taken to ensure that there is no build up at the corners or edges. If this does occur the excess is to be removed by trowel. On completion of the mist coat the Air Mover Pressure is returned to its normal setting 30 – 40 psi and the glass roving is fed into the spray gun. Finer mist coats can be achieved by using specialist mist coat guns. These are used when high quality architectural finishes are required. The GRC spraying should start immediately after the mist coat has been applied.

FACING COAT

For architectural finishes that are going to have a post treatment (sand blasting, acid etching), a facing layer consisting of cement, decorative sands and aggregates, pigments, polymer and water can first be sprayed. The thickness typically 4-6 mm is greater than that for the mist coat.



Power Tex Spray Gun

A PowerTex Spray Gun is used for the face coat spraying and the face coat can be left for a short time prior to the GRC spraying.

Spraying must be completed before the onset of the initial set of the facing coat.



Mist Coat Gun

SPRAYING

With the spray gun approx 300 mm from the mould surface and perpendicular to it, the first layer of GRC is sprayed in two passes, see diagram

North/South

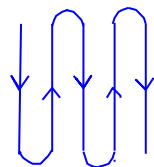

East/West

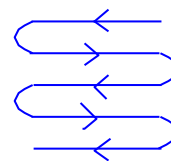

The speed of spraying is such that approximately 4-6 mm will be laid down in the two passes.

COMPACTION

After two passes are completed the spray man moves onto another mould and the sprayed material is compacted using a spring roller and a brush. The purpose of the rolling is to remove any entrapped air and to ensure that all the fibres are encapsulated by the slurry. The brush is used for compaction in corners and other areas where the roller cannot reach.

Spraying followed by compaction continues until the design thickness is achieved. This is checked using a thickness gauge and any areas of under thickness are marked and any additional material sprayed on to them.

SPRAYING OF TEST BOARD

During the spraying of the first mould each day a test board of nominal dimensions 600x600x10 mm should also be sprayed. The method of spraying and compaction of the board should be as the main unit. After spraying the test board should be set aside for subsequent testing.

PLACING OF RIBS, SOCKETS, STUD FRAMES

Many panels require strengthening ribs and/or the incorporation of sockets or frames for handling or fixing. Ribs are generally either solid GRC or GRC sprayed over a light weight former such as polystyrene. The spraying and compaction process is the same as for the main body of the panel. Sockets or the flex anchors of stud frames are encapsulated in premix GRC after their location has been accurately fixed. The premix GRC can be made by spraying into a bucket and mixing by hand. It is important that sockets are completely encapsulated. There must be no voids.

CASTING

Vibration

When moulds are filled with Premix GRC, vibration is used to ensure that the mould is completely filled and to remove air from the mix. Vibration coupled with the correct method of filling helps to prevent any air being trapped in the mould. This would lead to unsightly 'blow' holes on the surface of the product.



The most practical way to provide vibration is via a Vibrating Table. The size of the vibrating table used will depend upon the type of products manufactured. The mould should be clamped to the table to ensure that the vibration is transferred through the mould to the mix. A mould allowed to bounce on the table will not only cause damage to the mould but will lead to an inferior casting.

The frequency and amplitude of the vibration must be considered:-

A high amplitude is required to move the mix and completely fill the mould where as a high frequency will assist in compaction and consolidation of the small particles leading to high densities and good surface finish. Tables are available which allow variation of the frequency.

Standard tables are usually fitted with 3000 RPM motors and the force from each motor can be adjusted by varying the positing of eccentric weights on the motor shafts.

Self Compacting Premix GRC

Self Compacting Premix GRC requires little or no vibration. The use of a specialist plasticizer Flowaid SCC allows a very fluid mix to be produced. An integral stabilizer within the Flowaid SCC ensures there is no segregation. The advantages of SCC premix are,

- 1, No noise
- 2, No Health and Safety implications normally associated with vibration.
- 3, Longer mould life.
- 4, No need to move moulds on and off vibrating table.
- 5, Improved surface finish.
- 6, Can be pumped.
- 7, Facing Mix

Mould Filling

The correct method of filling is important. Incorrect filling can result in a defective product with poor surface finish. There are two golden rules. Moulds should be filled from one point normally the middle and the mix then allowed to flow to the perimeter. Filling from two points can cause a plane of weakness where the two mixes meet. When filling, air from the mould must be allowed to escape otherwise the product will contain large voids. These rules are illustrated in the following diagrams.

Always fill from one point.

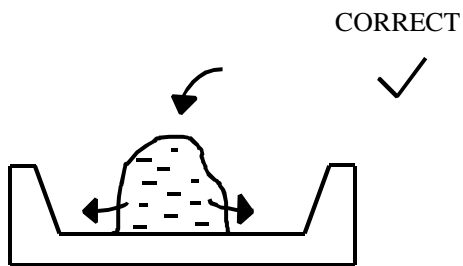

The Mould is filled from the middle and premix GRC is allowed to flow to the edge.

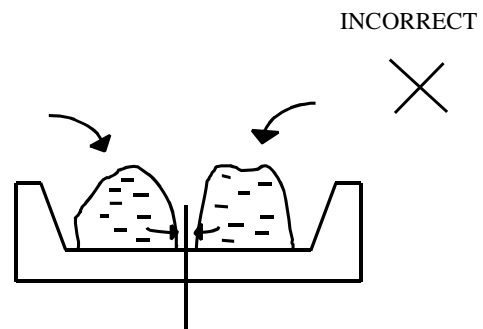

A plane of weakness is formed where the material from both sides meets as there will be no fibre bridging across the join.

Always let the air escape

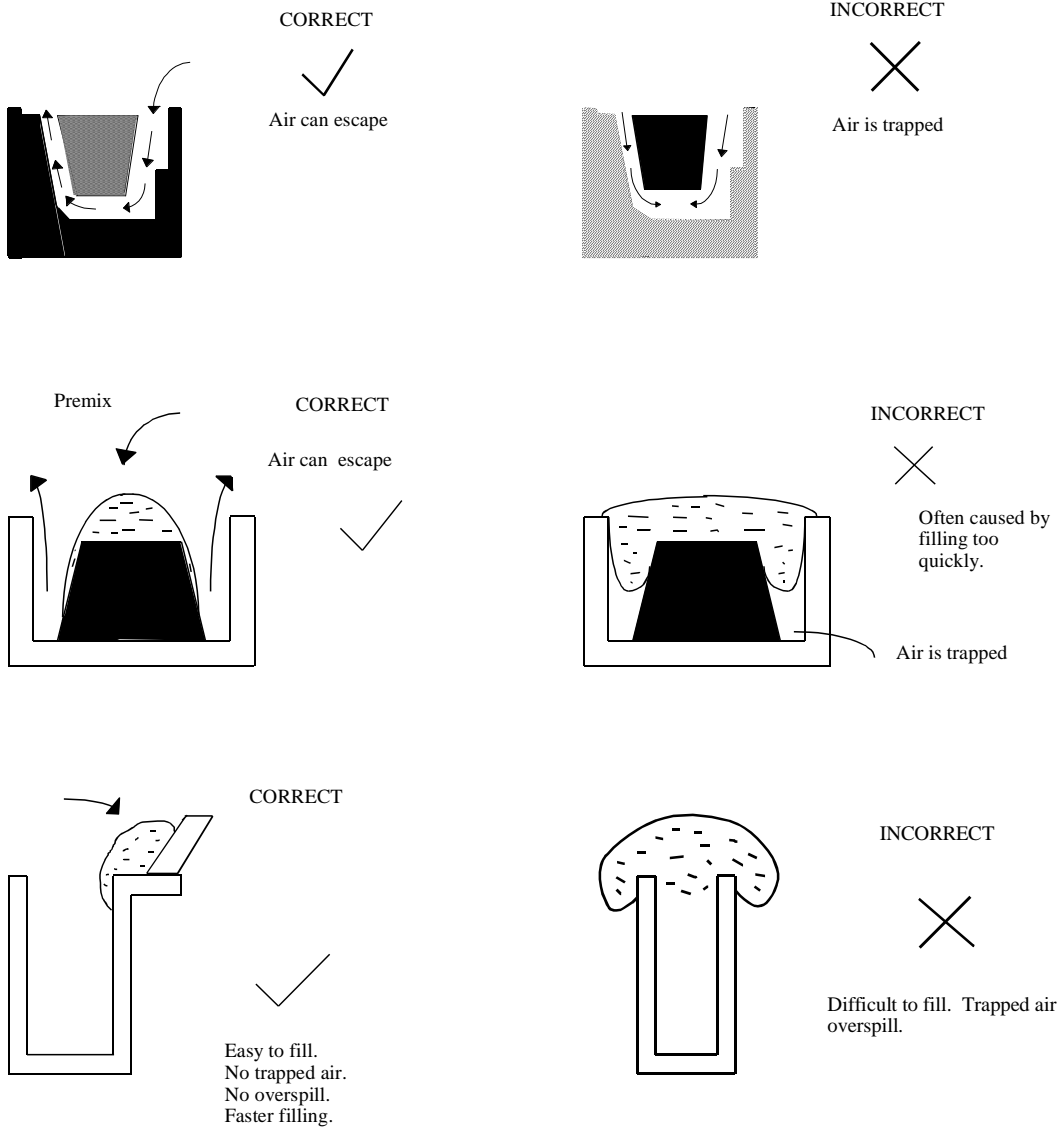

Sample Board

A suitably sized test board is 600 x 600 x 12 mm should be used. Using the same mix and the same method of vibration this board should be cast during a production run. This test board should be marked with an appropriate reference number and the casting date. After demoulding it should be cured under the same conditions as the castings it represents.

If the products cast are of a suitable size and shape then it is preferable to use them rather than a sample board.

Storage prior to demoulding

After spraying or casting, the filled moulds are taken to a storage area to harden. It is imperative that filled moulds are stored on a level base and that they are free from bow or twist. Large sprayed moulds are often in fixed positions and are not moved after spraying.

Considerable savings in time can be made if the mould is cleaned of any overspill or overspray at this stage. Final trowelling of the top surface if required also takes place now. Once the material has reached its initial set back shutters and cores can be removed. It is better that they are removed at this stage as the next day shrinkage will have made their removal more difficult.

The product should be marked with a reference number and the date of production and, after a final inspection, is covered by a polythene sheet until demoulding.

CLEANING

Once production is complete or if there is a lengthy break in production, the equipment must be thoroughly cleaned.

The correct operation of Mixing, Pumping and Spraying equipment is only maintained if it is kept clean.

Detailed cleaning instructions are supplied with all Power-Sprays equipment and they should be followed.

DEMOULDING AND HANDLING

WHEN TO DEMOULD

GRC components must not be demoulded until they have gained sufficient strength so that they may be demoulded and transported without over stressing.

With normal OPC mixes and temperatures around 20 degrees C. demoulding can normally take place 12 - 18 hours after casting. Changes to the mix design can allow 2 –3 casts per mould per day but low temperatures can lead to only one cast in two days.

METHODS OF DEMOULDING

The method of demoulding should be decided during the manufacture of the mould. If "tip out" moulds are required then there must be sufficient draw, whereas if 90° sides are required then the mould sides must be either hinged or removable. Even with the correct draw inner cores can prove difficult to remove as the GRC has a tendency to shrink on.

When components are demoulded by mechanical means it is normal to use a lifting beam or frame and the advice of the Design Engineer should be sought in the positioning of the lifting points.

HANDLING

As with demoulding the panel must be handled in such a way as to minimise any induced stress.

CURING

It is important to understand the reason for curing products and how cure is achieved.

GRC starts to hydrate after the initial set has been achieved and this hydration then continues for the life of the product. In practical terms 95% of hydration will be complete by 28 days for concrete products and because of its higher cement content, GRC hydrates at a faster rate and after 7 days approximately 95% of hydration would be complete.

To enable hydration to proceed water must be present within the product. There is sufficient water in the mix and the aim of curing is to keep this water in the product. Provided this is done, additional water for curing is not necessary. Water can be kept in the product either chemically using polymers or by maintaining the product in a humidity of 95% such that water will not evaporate from the product.

Dry Cure

Dry cure using a Polymer modified mix.

1. If this method is to be adopted the polymer addition will be catered for in the mix design.
2. After completion of spraying the product is to be polythene covered and maintained at a temperature between the minimum film formation temperature of the polymer and 40 degrees centigrade prior to demoulding.
3. After demoulding the product can then be air cured either inside the factory or in the stockyard. During winter months or when frost is expected the products should be stored inside for a further two days after demoulding.

Moist cure

1. After completion of the spraying process the mould is covered with polythene within one hour.
2. After demoulding the product is either;
 - a. Stacked on a pallet and shrink wrapped
 - b. Stacked in curing area and covered in polythene
 - c. Stacked in purpose built humidity and temperature controlled curing chamber

When b. is adopted the product is to be wet down daily. In certain conditions this may be more frequent dependent upon humidity readings.

Moist cured products are normally to be kept inside for a period of seven days.

FINISHING – STORAGE

After completion of the curing period and prior to delivery products are normally stored in an external stock yard. Panels should be stored and transported in a way that will:

1. Protect vulnerable areas of the product from damage.
2. Ensure no distortion of product.
3. Ensure no staining or discolouration to "seen" areas of the product.
4. Minimise the amount of handling.

The method employed will depend upon the type of product but can range from small components stacked on top of each other and shrink wrapped on pallets, to large architectural panels being stored and transported vertically on "A" frames.

QUALITY CONTROL TESTING

INTRODUCTION

As well as correctly calibrating the Spray Equipment by use of the Bag and Bucket Tests it is necessary to ensure that the correct amount of uniformly distributed glass fibre is being used and that the mechanical properties obtained from the finished product are in accordance with the specification.

In order to test the above, sample boards are produced daily. These boards 600 x 600 mm are cast/sprayed during the production of the first panel and are produced in the same manner as the panel and are considered representative in terms of material quality.

Once the sample board has been completed determinations of glass content are carried out immediately so that if the results do not correspond with the calibration, the calibration procedure can be repeated. This test is not essential with Premix GRC where the percentage of fibre is accurately known although it can be used to check the uniform distribution of the fibre. The remainder of the sample board is cured in the same manner as the panel for seven days, when flexural and density tests are carried out.

Test methods and forms for recording results are attached. Reference can also be made to EN 1169, EN 1170 (1-8).

DETERMINATION OF GLASS CONTENT

Often referred to as the "wash out" test.

Principle

The glass content is determined by comparing the mass of specimens before and after all material other than the glass fibre has been washed away.

Test Specimen

The test specimens shall be taken from a test board prepared so that it represents the product in composition, manufacturing process and thickness. The specimens shall be cut from the green state using a sharp knife resulting in the test specimens having clean, cut edges. The specimen size shall be nominally 150 mm x 50 mm and not less than 3 test specimens shall be taken from a test board to obtain a mean glass content for the board. The specimens should be chosen so as to be as representative as possible of the total areas of the test board.

Apparatus

- Mesh baskets 175 x 100 x 25 mm made from 3 mm stainless steel mesh to BS481. One basket is needed for each specimen tested.
- Laboratory Balance Capable of weighing 1,000 grams in increments of 0.1 gram maximum, accurate to +/- 0.05 gm.
- Laboratory Muffle Furnace With ventilation, capable of maintaining a temperature of 500°C, +/- 20°C

or

- Laboratory Oven With forced air circulation and ventilation capable of maintaining a temperature of 110°C, +/- 5°C.

Note: Microwave oven can also be used but in this case metallic baskets cannot be used.

Procedure

1. Weigh a dry mesh basket and record its weight (M1).
2. Place a specimen in the weighed basket. Reweigh the basket and its contents and record the total weight (M2).
3. Place the baskets and contents under a stream of running water and work the specimen with fingers or suitable implement to break it up, ensuring that no glass fibre is lost.
4. When all the cement and other solid particles other than the glass fibre have been washed away dry the basket and its contents to a constant weight either in the oven (110°C for approximately 4 hours) or in the muffle furnace (500°C for approximately 5 minutes).
5. At the end of the heating period remove the basket and its contents from the oven or furnace and allow to cool to room temperature (preferably in a desiccator).
6. When cool, reweigh the basket and its contents and record the total weight (M3).
7. Repeat procedures 1 - 6 for each additional specimen tested.
8. Calculate the glass content (by weight) using the formula:

$$\text{Glass Content (\%)} = \frac{M_3 - M_1}{M_2 - M_1} \times 100\%$$

WASHOUT TEST

Procedure for determination of glassfibre content.

Spray up a test board

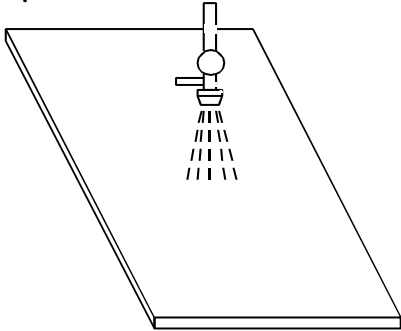

1

Trowel smooth and cut test specimen

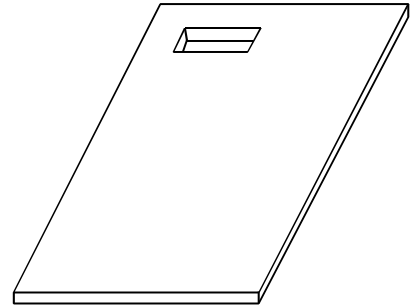

2

Place sample in wire mesh trays.

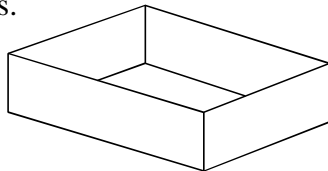

3

Weigh tray and sample

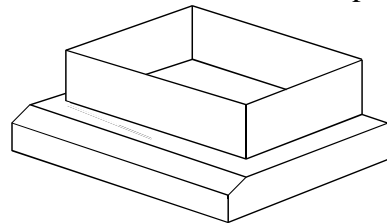

4

Wash out Gently

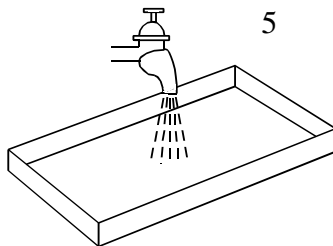

5

Oven at 500°C

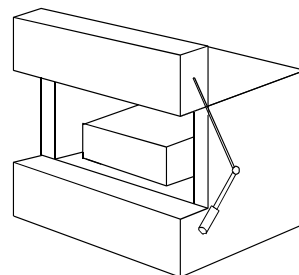

6

Reweigh

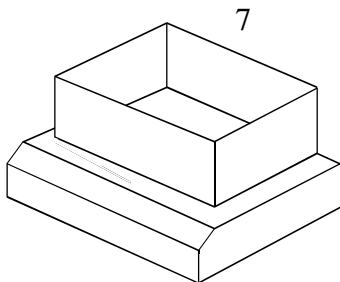

7

Test report

The test report shall refer to EN1170 and the following particulars as necessary:

1. Test board identification mark, date of test and other pertinent data concerning the tested material.
2. The number of test specimens taken as a sample.
3. The arithmetic mean value of the glass content of all the results from the board tested and the range of the results

WASH OUT TEST

Team No:.....

Test Board No:.....

Time:.....

		Sample A	Sample B	Sample C	Average (%)
Dry Basket Weight (g)	M1				
Specimen + Basket Weight (g)	M2				
Specimen Weight (g)	M2- M1				
Dry Glass + Basket Weight (g)	M3				
Dry Glass Weight (g)	M3- M1				
Glass Content (%) = $\frac{M_3 - M_1}{M_2 - M_1} \times 100\%$					

DETERMINATION OF FLEXURAL STRENGTH

Flexural & Tensile strength are the most important mechanical properties of GRC unlike concrete where compressive strength is the most important parameter.

A cube test is therefore not relevant for GRC and a 4-point flexural test has become the accepted standard.

Principle

The deflection of rectangular specimens of cured GRC is measured using four-point loading until failure occurs. The dimensions of the specimens are measured and the Limit Of Proportionality (LOP), Modulus Of Rupture (MOR) are calculated from these measurements. This four-point loading imposes pure bending forces over the middle third of the test specimen and is preferred to the three-point loading test where the stress is concentrated at the centre. This method is not applicable to thicknesses of more than 20 mm.

Apparatus

- Testing Equipment Capable of operating at a constant crosshead rate and including a calibrated load measuring system and capable of indicating the load to within $\pm 1\%$ of the actual applied load and of indicating deflections which do not exceed $\pm 2\%$ actual deflection.

- Bending Test jig (Fig.1) Comprising supports and loading rollers of 6 mm minimum diameter and of 52 mm length, with an adjustable distance between the supports to give the major and minor span distances given in Table 1, and designed so that the force applied to the specimen is perpendicular to the surface and is applied without eccentricity.

- Silicon Carbide Saw - or other suitable equipment.



Test Specimen

Cut the specimens from a test board which is representative in composition and thickness of the cured GRC material

Cut each specimen with a width of 50 mm +/- 2mm and a length of between 25 mm and 50 mm greater than the major span dimension for the appropriate specimen thickness as given in Table 1. Prepare rectangular specimens with parallel sides and mark them to identify the mould or trowel faces.

A minimum of four specimens should be cut from each board.

Procedure

1. Soak specimens in potable water at room temperature for a period of between 4 and 24 hours.
2. Set the major and minor spans of the bending test jig to the appropriate values for the specimen thickness given in Table 1, and align the loading rollers and supports so that the axes of the cylindrical surface are parallel. Record the major span (L).
3. Remove the specimen from the water, wipe off surface droplets with absorbent cloth or paper and commence test within 2 minutes.
4. Place the specimen in its correct attitude, symmetrically across the two parallel supports ensuring that the length of the test specimen is at right angles to the supports and that equal lengths of the specimen project beyond the rollers.
5. Adjust the testing machine so that its crosshead speed corresponds with Table 1.
6. Start the test machine and continue until sample failure.
7. Record the load (W1) at the limit of proportionality, ie. the load at which the load deflection curve deviates from linearity and the maximum load (W2).
8. Measure and record the specimen thickness to the nearest 0.05 mm at a minimum of three points, and calculate their arithmetic mean (d) together with the specimen width (b) to the nearest 0.1 mm at or near the failure location, taking care not to choose places where the specimen may have been expanded during the test.
9. Disregard the results from any specimen that breaks outside the central third of the distance between the rollers and repeat the procedure with another specimen. Record the occurrence of such cases.



Calculation and Expression of the Results

Modern test machines are supplied with programmes to calculate the results but they can also be calculated manually using the following

Limit Of Proportionality	Modulus Of Rupture
$\text{LOP} = \frac{\mathbf{W1 L}}{\mathbf{bd^2}} \quad \text{N/mm}^2$	$\text{MOR} = \frac{\mathbf{W2 L}}{\mathbf{bd^2}} \quad \text{N/mm}^2$

Note:

- W1 = LOP Load (in N)
- W2 = Failure load (in N)
- L = Major Span (in mm)
- b = Specimen width (in mm)
- d = Arithmetic mean of three specimen thickness measurements (in mm)

Calculate and record the arithmetic mean of the results obtained from the LOP in N/mm².

- a. For the specimens tested with their mould or trowel faces in contact with the major span supports.
- b. For the specimens tested with their mould or trowel faces in contact with the minor span supports.
- c. For all the specimens.

Analysis

Monitor and analyse the results to ensure compliance with the specification.

Typical Load Deflection Curve

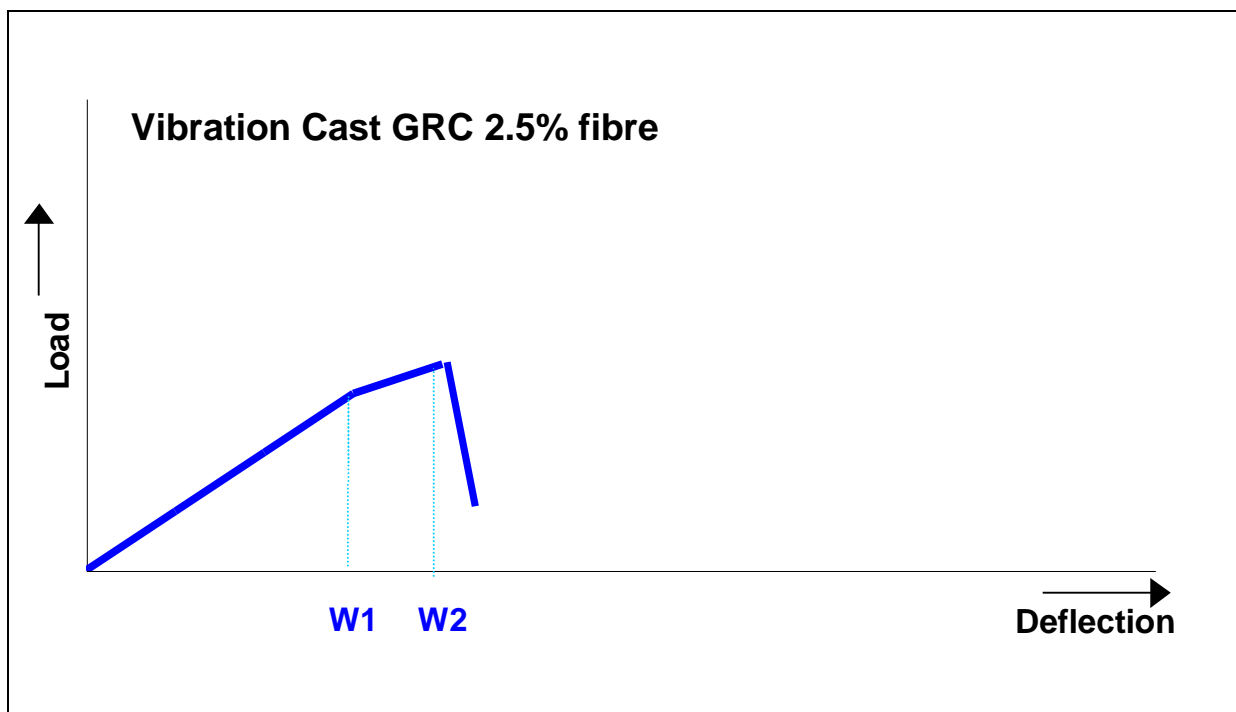
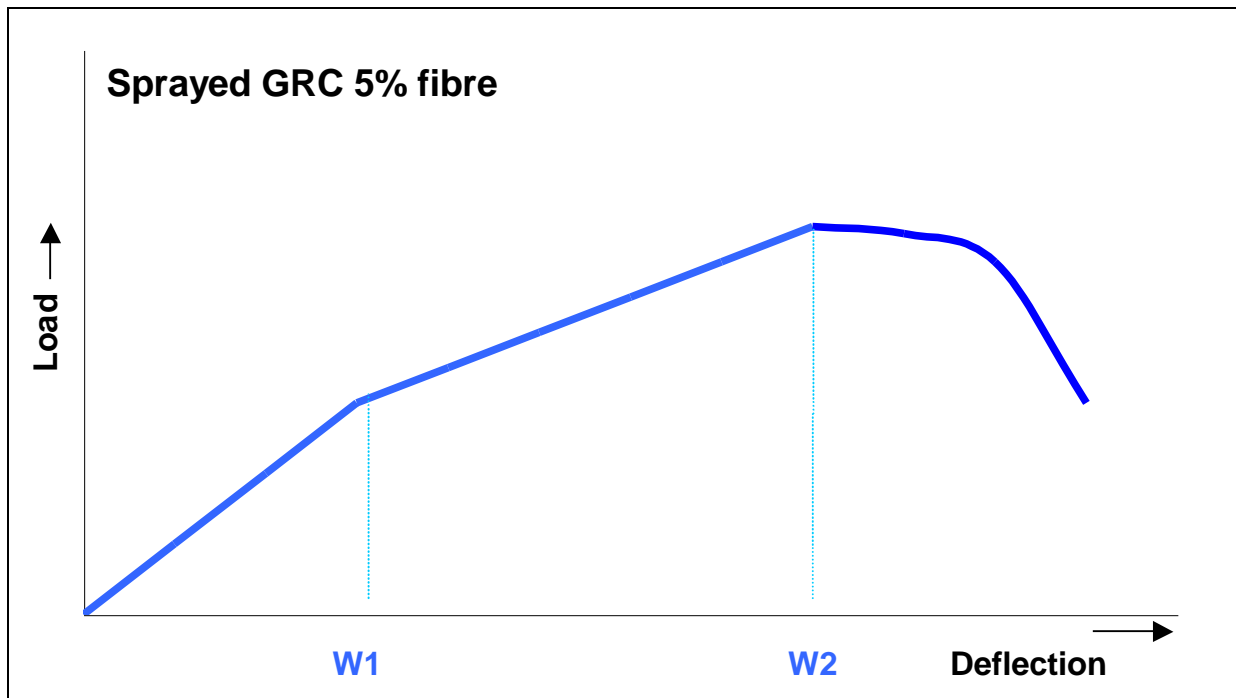
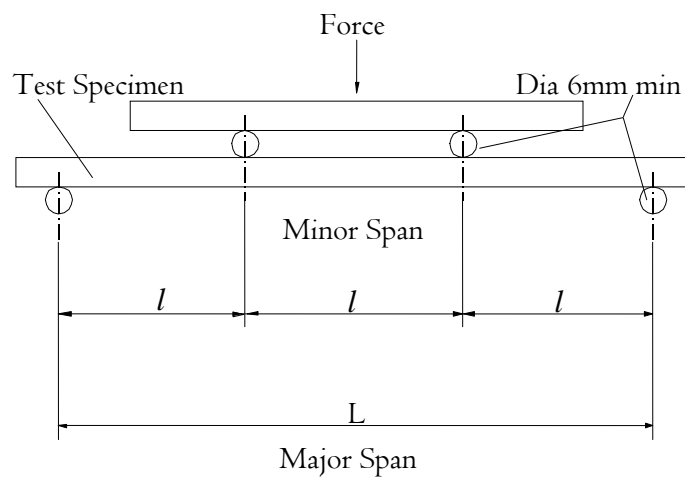

TABLE 1**MAJOR AND MINOR SPAN LENGTHS AND CROSSHEAD SPEEDS FOR VARIOUS SPECIMEN THICKNESSES**

Nominal Specimen Thickness (mm)	Major Span (mm)	Minor Span (mm)	Crosshead Speed (mm/min)
Up to 6.7	135.0	45.0	1.5 - 3.0
6.8 to 10.0	200.0	66.7	1.5 - 3.0
10.1 to 12.5	250.0	83.3	1.5 - 3.0

Figure 1.

**Position of specimen on bending test jig**

DETERMINATION OF THE DRY AND WET BULK DENSITY, WATER ABSORPTION AND APPARENT POROSITY OF GRC MATERIAL

Principle

The apparent mass of specimens suspended in water is measured after a period of immersion in water. The mass in air is then measured after removing surface water and again after drying in a desiccator. The dry and wet bulk densities, water absorption and apparent porosity are calculated from these measurements.

Test Specimen

The test specimens shall be taken from a test board prepared so that it represents the product in composition, manufacturing process, curing and thickness. The specimens shall be cut from the cured test board using a silicon carbide saw or other appropriate equipment. The specimen size shall be not less than 50mm x 50mm and not less than 2 specimens shall be taken from a test board to obtain mean values. The test specimens should not be taken from adjacent areas and should be free from visible cracks, fissures or broken edges.

Apparatus

- Specimen Holder Capable of suspending the specimen in water and made of a material that does not absorb water.
- Laboratory Balance Capable of weighing 500 grams in increment of 0.01 grams maximum, accurate to + 0.005 grams.
- Laboratory Oven With forced-air circulation and ventilation capable of maintaining a temperature of $110^{\circ}\text{C} \pm 5\text{ C}$.
- Dessicator Of adequate size and to contain a suitable desiccant eg. 'tell tale silica gel'.

4. Procedure

1. Immerse the specimen in fresh water for a period of 16 – 24 hours at a temperature of $20^{\circ}\text{C} \pm 5\text{ C}$.
2. Weigh the specimen when suspended in water and record its apparent mass (M1) excluding the specimen holder.
3. Remove the specimen from the water and its holder, quickly remove the surface water with absorbent cloth or paper and immediately weigh the specimen in air (M2).
4. Heat the specimen in the oven at a temperature of $105^{\circ}\text{C} \pm 5^{\circ}\text{C}$ to constant weight (approx 24 hours).
5. Remove the specimen from the oven; allow to cool in a desiccator to room temperature and weigh (M3).
6. Repeat the above procedures for each additional specimen tested.

Calculation and Expression of Results

The properties are calculated using the following formula.

1. Dry Bulk density (kg/m³) = $\frac{M_3 \times 1000}{M_2 - M_1}$
2. Wet Bulk density (kg/m³) = $\frac{M_2 \times 1000}{M_2 - M_1}$
3. Water absorption (% by weight) = $\frac{(M_2 - M_3) \times 100}{M_3}$
4. Apparent porosity (% by volume) = $\frac{(M_2 - M_3) \times 100}{M_2 - M_1}$

Test Report

The test report shall refer to GRCA S 0103/-0481 GRCA Methods of Testing Glassfibre Reinforced Cement (GRC) Material and the following particulars as necessary:

1. Test board identification mark, date of test and other pertinent material.
2. The number of test specimens taken as a sample
3. The arithmetical mean value for each property and the range of the results

SECTION 3. EXAMPLES

TYPICAL SPRAYED PRODUCTS

PAGE 51

Single Skin Permanent Formwork
Single Skin Cladding With Perimeter Rib Boxes
Stud Frame Panel

TYPICAL PREMIX PRODUCTS

PAGE 58

Patio Tile
Cable Duct and Lid
Sunscreen

TYPICAL SPRAYED PRODUCTS

SINGLE SKIN PERMANENT FORMWORK

Refer to Diagrams

The moulds would be manufactured from GRP or steel with the edge strips having a taper or draw to enable demoulding by 'Tip Out'.

These moulds would first be coated with release agent applied by spray or brush and any excess would be removed by cloth.

Using a suitable mix design the slurry is mixed in a high shear mixer and then transferred to the pump. After the bag and bucket calibration checks spraying can commence.

A mist coat maximum thickness 0.5 mm is first sprayed onto the mould and this is immediately followed by the first layer of GRC.

This is sprayed north/south east/west as described earlier in the text. The speed of spraying should be such that approx 4 mm sprayed in this first layer.

The GRC is compacted by means of a roller and the edges turned in. The second layer is then sprayed exactly as the first but notice as the edges are already of the required thickness they do not require spraying again. After spraying the GRC is again compacted and checked for thickness using, a depth gauge. Any areas of under thickness must be resprayed.

Once this has been completed any unsprayed parts of the mould edge strips ends etc. are cleaned and the moulds stacked and covered in polythene prior to demoulding the following day.

Remember to spray a sample board.



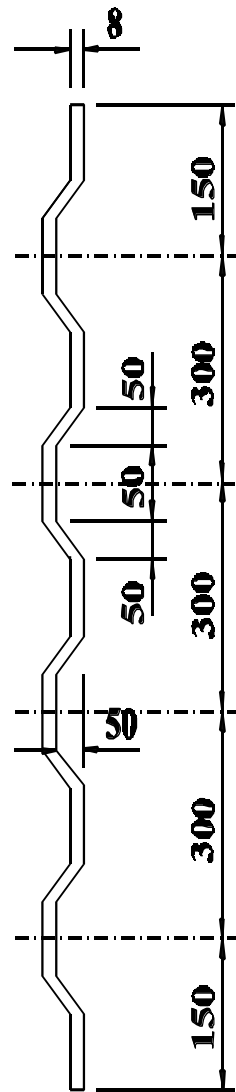
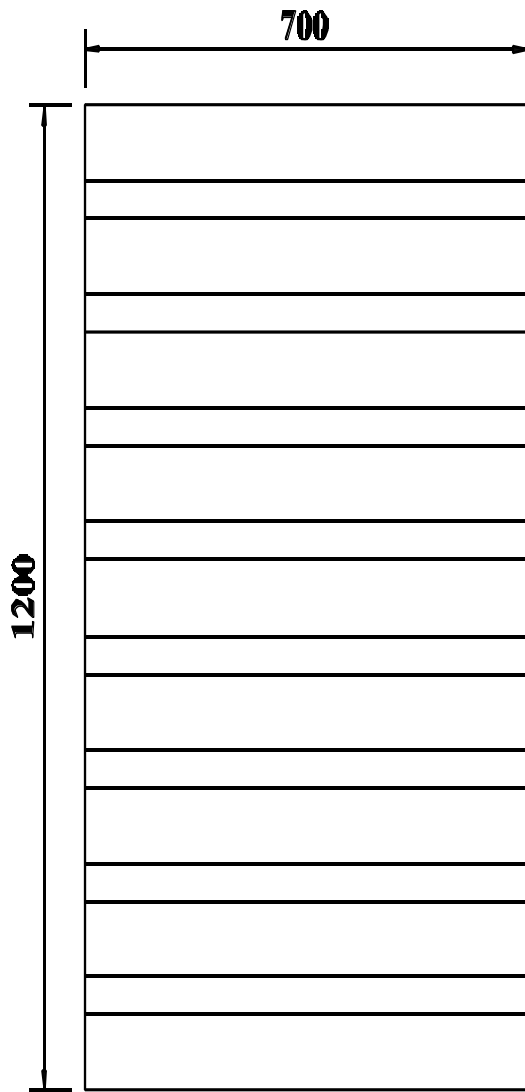

Typical Permanent Formwork

Single Skin Panel

SINGLE SKIN CLADDING WITH PERIMETER BOX RIBS.

Depending on the quantity of casts required the mould can be manufactured from steel, GRP or timber.

The moulds are assembled, checked dimensionally and to ensure squareness and that it is on a level base. It can then be treated with release agent prior to spraying.

Assuming mixing and calibration checks are complete spraying can commence. A mist coat maximum 0.5 mm thick is sprayed onto all faces of the mould. This is immediately followed by the first layer of GRC. This is compacted by roller paying particular attention to edges and corners.

These are particularly important and minutes spent at this stage will save hours making good at a later date.

The 2nd layer of GRC is sprayed and compacted and the thickness is checked with a depth gauge. For panel thickness 12-15 mm a third spray may be necessary.

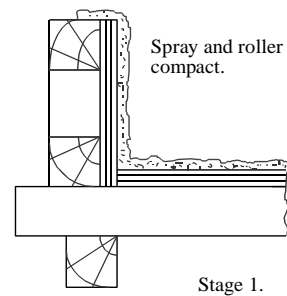

The pre-cut rib formers are now placed. Note how the corners of the polystyrene have been chamfered to accommodate the build up of GRC at the mould edges.

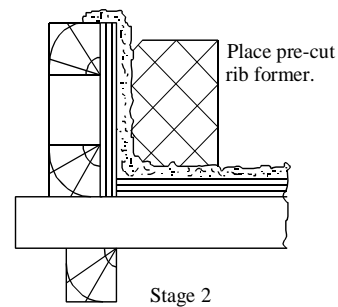

The polystyrene formers do not extend to the mould corners as here fixing sockets are encapsulated in solid GRC

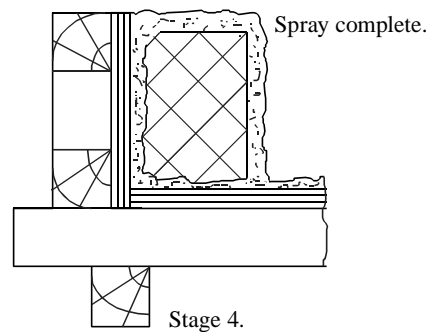
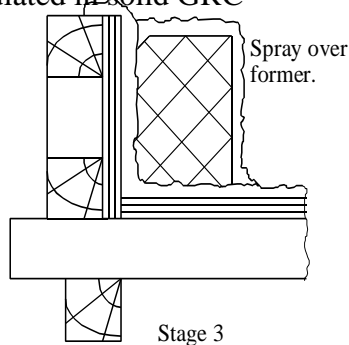

Once these sockets have been correctly located and all the rib formers placed two layers of GRC with compaction between are sprayed over the rib formers. Stages 3-4 on the diagram show how this is achieved.

The GRC encapsulating the sockets can either be sprayed directly around the socket or first sprayed into a bucket, mixed and placed around the sockets by hand. Experience has shown that this second method gives the best results although it is necessary to reduce the glass % to 2.5 to 3 aid compaction. This can be done by switching off the chopper motor for half the time while spraying into the bucket.

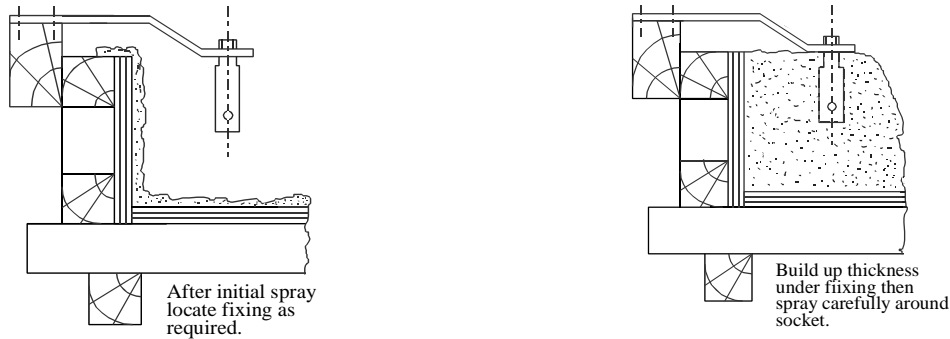

The edges and sides of the mould are now cleaned and the mould is polythene covered. If the mould has been moved during the production process it is essential that it is checked to ensure that it is level and not twisted. Note a panel made from a twisted mould will always be a reject.

After 8-12 hours depending on temperature the panel can normally be demoulded. An assessment must be made that the GRC has hardened sufficiently for the demoulding to take place.

A panel of this size 3m x 1m would normally be demoulded using a lifting beam or frame probably attached to the corner fixing sockets.

Once demoulded the panel would be marked with an identification number and transferred to the curing bay. It would be handled and stored on edge.

After curing for 7 days it would be transferred to the stock yard prior to delivery to site.

Any remedial work to the panel could be done immediately on demoulding or at the end of the curing period.



TYPICAL SINGLE SKIN PANEL WITH BOX RIBS

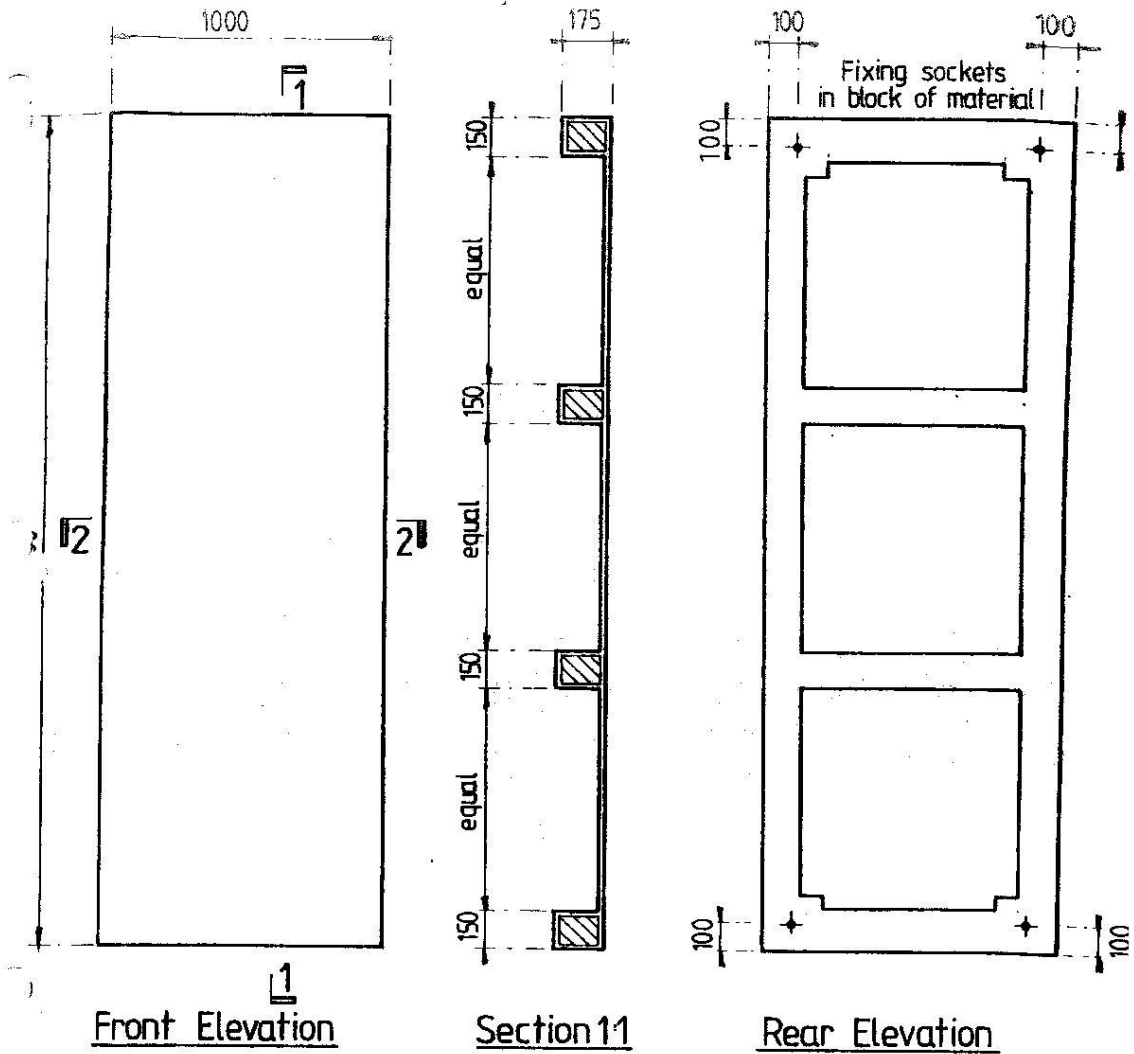

Front Elevation

Section 1:1

Rear Elevation

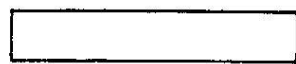

Plan



Section 2:2

TYPICAL SINGLE SKIN PANEL WITH BOX RIBS

STUDFRAME PANEL

Refer to Diagram

The use of a 'stud frame' allows large single skin panels to be fabricated without the need for GRC strengthening ribs. The incorporation of fixing and lifting sockets is also not necessary as these are an integral part of the frame. The connection to the panel and the frame is by 'flex' anchors which allow movement of the GRC frame relative to the panel. The advice of an engineer should always be bought for the design of stud frame panels.

The spraying of a stud panel is similar to the previous examples but on a larger scale. It will be necessary to ensure that there is a continual supply of slurry to the pump and that there are sufficient personnel compacting to keep up with the spray man. Thickness checking becomes even more important particularly in the areas in the centre of the mould which may be difficult to reach. When all the areas of the mould have been sprayed and compacted the stud frame is placed onto the mould. The positioning of the stud frame is critical and locations should be built into the mould to ensure that this positioning is exact.

These locations must also bear the weight of the frame which should not be allowed to rest on the recently sprayed GRC. There are three methods of bonding the flex anchors to the panel.

1. Green sheet over lay method.
2. Direct spray.
3. Hand pack.

In each case the bonding must take place as soon as possible after the placing of the frame. Any delay can affect the integrity of the bond and hence that of the panel.

Once all the anchors have been bonded the mould is cleaned and polythene covered prior to demoulding. Remember to check for levelness and that a sample board has been sprayed.

Due to the size of the panels care must be taken in demoulding, handling storage and transportation and it is recommended that the method chosen is discussed with the engineer prior to the start of the contract



STUD FRAME DETAIL FOR PANEL TPC

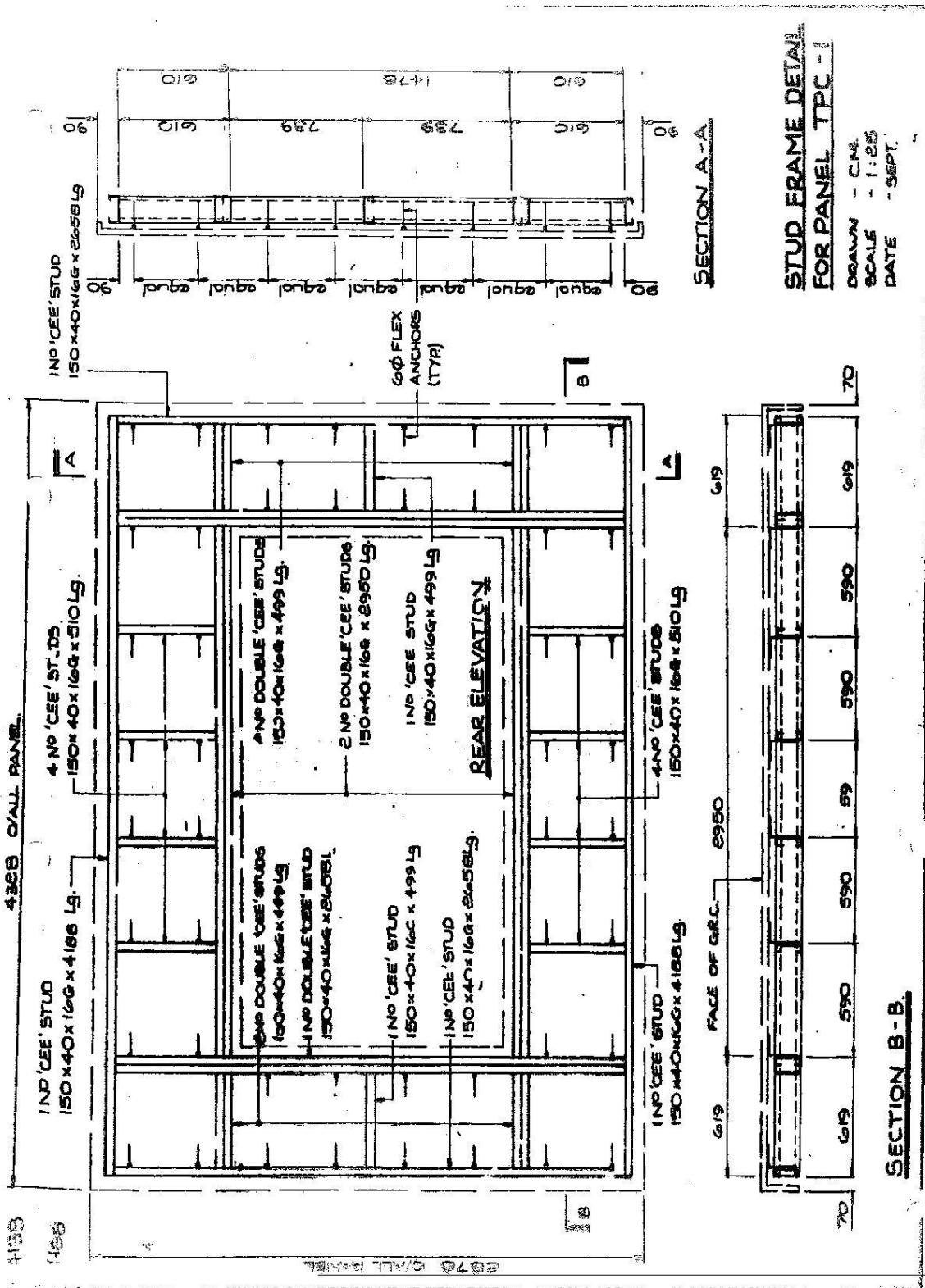

TYPICAL PREMIX PRODUCTS

PATIO TILE

These are a 300 x 300 tile 10 mm thick with a textured surface the moulds would be manufactured using a polypropylene liner on a plywood base with soft wood edge strips.

A mix design similar to the one described earlier in the text would be used.

Each tile mould requires 1.9 kgs of material and this amount can be conveniently dispensed using a jug of the required volume.

Empty moulds are placed onto the vibrating table and filled with the jug ensuring the material is poured centrally onto each mould. The moulds are then held down to the table until the material has completely levelled. The moulds are then removed, the edges cleaned and stacked on racks prior to demoulding.

Demoulding is a simple tip out procedure, the edges of the tile are cleaned to remove any flashing and the tiles are stacked for curing. The moulds are inspected and returned for production. After curing the tiles are stacked on pallets and shrink wrapped prior to delivery.

Patio Tile

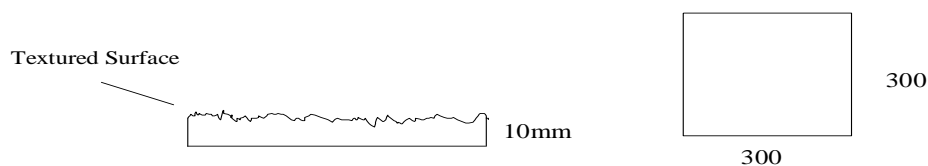

Mould

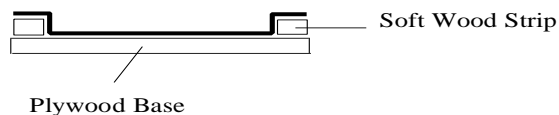

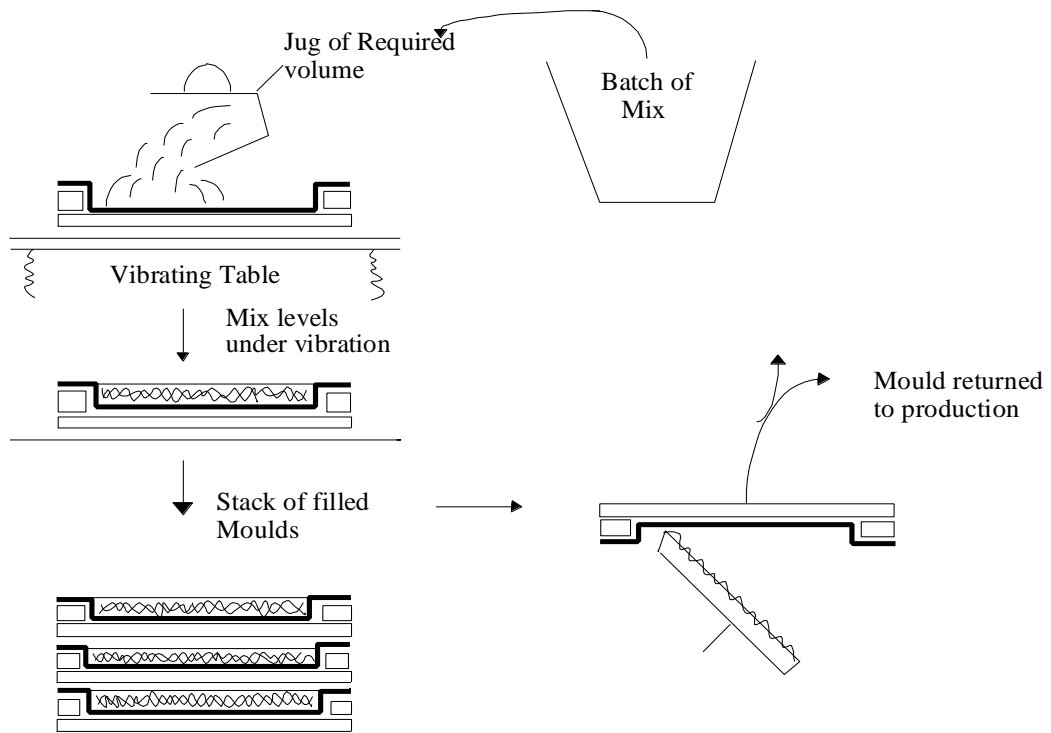

CABLE DUCT AND LID

To take full advantage of the properties of GRC cable ducting is made in 2 - 3 m lengths. This gives it distinct advantages over concrete which must be made in much shorter lengths to be handleable. Lids are usually in 1 m lengths.

Typical cross sections would be Troughs

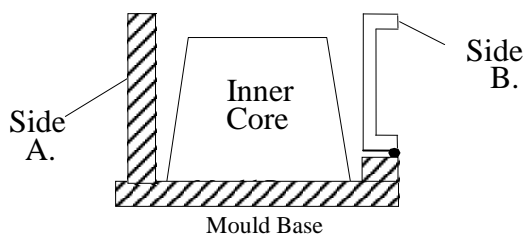
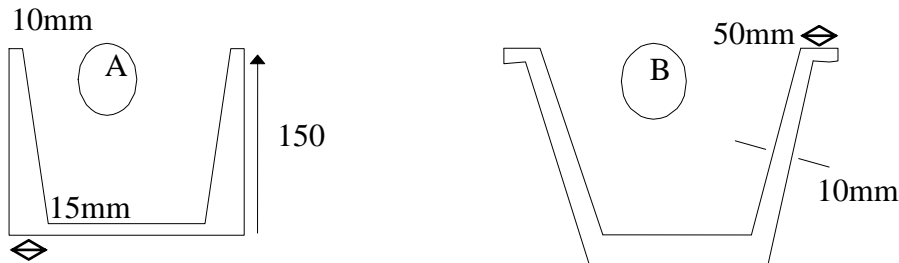

Moulds

When ducts are standard products the moulds are normally made of steel but they can also be made of GRP or even timber for short production runs.

The basis of the trough mould is an inner core with sufficient draw to allow demoulding. Compressed air nozzles in the core will simplify this procedure. The sides can either be hinged or removable.

A mix design with good flow characteristics should be selected. Fibre contents are generally 2-3.5% depending upon the section thickness.

The empty moulds are cleaned and coated with release agent. It is much easier to coat the core prior to assembling the sides.

The mould is then placed on the vibrating table and is filled following the rules given earlier. Once filled it is removed from the table and stacked on a level base. Trowelling of the back can take place now or an improved finish can be obtained if this process waits until the initial set has started.

Cleaning of mould edges should also be done at this stage.

When the cast is ready for demoulding the sides are removed and the mould and cast are turned upside down. The casting can then be removed by the use of compressed air or by gentle tapping with a rubber mallet.

After curing, during which it is important that no bow is induced in the unit they are stacked on pallets either with the lids in place or with the lids on separate pallets.

SUNSCREEN

Sunscreens are probably the most widely manufactured GRC premix product in the Middle East. They have been successfully produced for over 20 years and designs have become more and more elaborate.

Moulds

Except for very simple geometric patterns sunscreens are universally made using flexible rubber moulds. Moulds can either be 'bought in' or manufactured in house. A 'master' being an exact replica of the screen required is first carved in timber or produced from gypsum. It is fastened to a base board and treated with release agent. The rubber is then mixed and poured over the master and allowed to set. Once set the rubber mould can be peeled from the master. Rubber moulds are normally contained within an outer wooden mould for ease of handling and to ensure the rubber does not distort with time.

A mix design as described earlier would be used with white cement replacing the OPC. The mix would be deposited in the middle of the mould and allowed to flow to the edges under vibration, for large screens a trowel should be used to assist. Once the mould has been filled a straight edge should be used to ensure the mould is completely but not overfilled.

The mould is then removed from the vibrating table and placed on a level base. After 1-2 hours the back surface can be floated to achieve as smooth a finish as possible. The mould is then covered in polythene prior to demoulding.

Demoulding must be carried out carefully to ensure no damage either to the mould or to the screen. One method is to lift the mould and screen into a vertical position and then to gently peel the mould away from the screen. The screen should then be handled stacked and transported vertically.



SECTION 4. APPENDIX

STONE FACED GRC

CHOICE OF FIBRE

HEALTH AND SAFETY

TYPICAL CERTIFICATIONS OF CONFORMITY

STONE FINISHES FOR GRC PRODUCTS

GRC has a wide flexibility in design and manufacture which enables it to reproduce most architectural styles and features. It can replicate virtually any surface detail and reproduce the appearance of materials such as stone, slate, terra cotta and marble. Carved stonework involves specialised skills and is slow to produce making the end product expensive. GRC can match stonework in appearance and as it can be produced in thin sections it is easier to handle and fix.

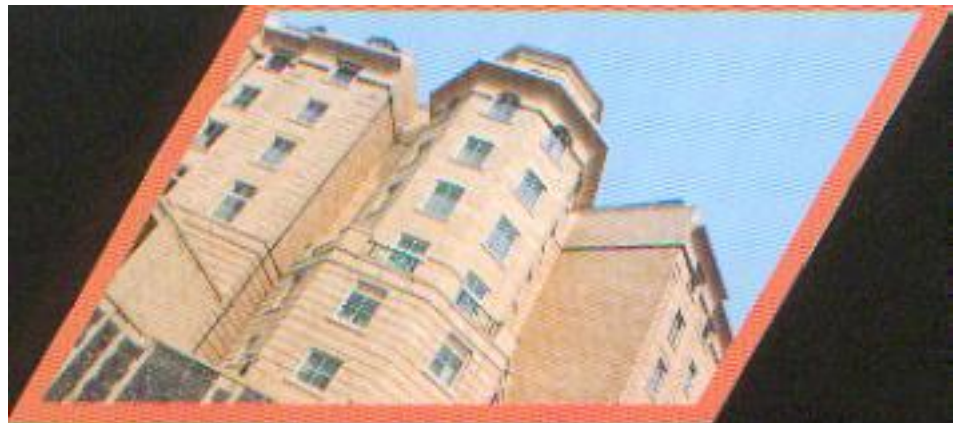

STONE FINISHES

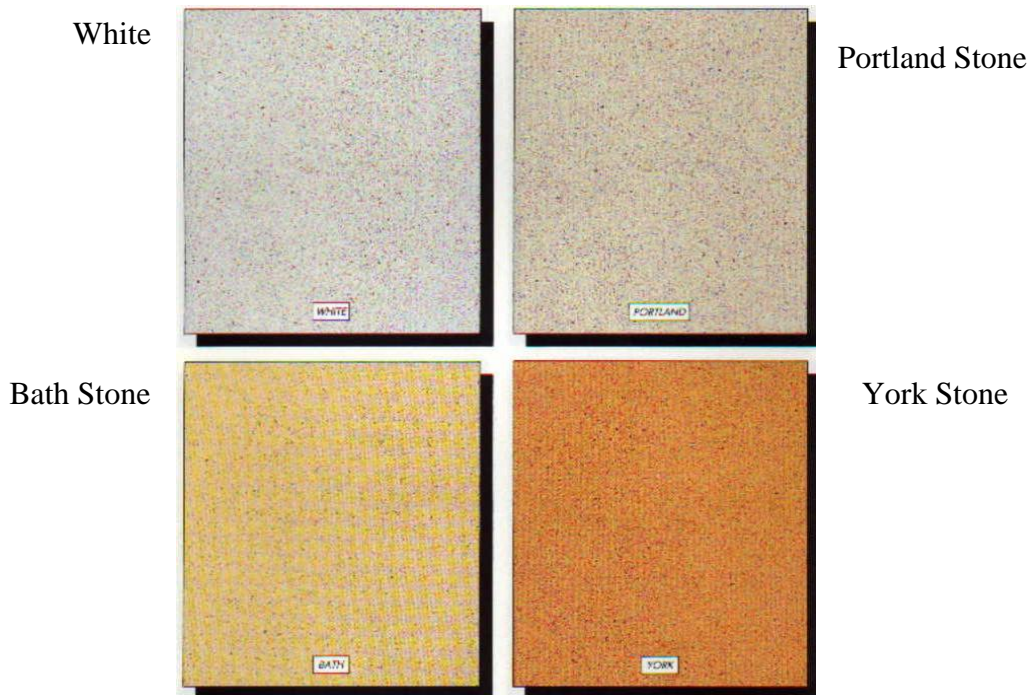

These are "fine" finishes with textures similar to sand paper. They are produced by first spraying a facing layer of cement, sand/aggregate, pigment and water on to the mould first and then backing up with GRC. The GRC should be sprayed as soon as possible after spraying the facing layer. The thickness of the facing layer is not included in the design thickness of the GRC but the additional weight must be taken into consideration.

After demoulding the texture is obtained by acid washing, sand blasting or rubbing.

This type of finish is currently very popular because the aggregate used is fine and the facing layer needs only to be 4-6 mm thick and this only adds 8-12 kgs/m² to the panel weight. As the facing layer is sprayed this method is particularly suitable for complex shapes.

The facing layer can be sprayed using a POWERTEX MK 3 Spray Gun for mixes containing aggregates with a particle size up to 4mm. If only 1mm. aggregate is used then the normal GRC spray gun and pump can be used.

EQUIPMENT – Power-Tex Mk. 3 Spray Gun

The Powertex Spraygun is suitable for aggregate up to 4mm particle size. When sands of 0-1 mm are used then the PS9000A pump can be used.



Raw Materials

- Cement (usually white)
- Sand/Aggregate

The choice of aggregate is important. It should be a hard crushed rock and should be clean and well graded between 0-3 mm. Granite, quartz, calcite and spars are particularly suitable. It is worthwhile spending time searching for one or more suitable aggregates locally. If they are available, but not of the right grading it should be possible to sieve out the oversized particles.



Typical Fine
Aggregates



- Pigment - Iron Oxide type
- Acid - Hydrochloric Acid

This should be diluted with 3 or 4 parts of water prior to use.

- Acrylic Polymer

It is very important to use an acrylic polymer to allow a 'dry' cure and to reduce the chances of crazing or micro cracking in the facing layer. Pure acrylics are to be preferred as they are stable in UV. light whereas other types of polymer have been known to yellow with time giving unsightly marks on the face of the panels. To be effective the polymer must be used at the correct dosage level of 5% polymer solids by weight of cement. For a polymer with a solids content of 50% this is equivalent to 5kgs polymer emulsion to 50kgs of cement. Polycure FT supplied by Fibre Technologies International is a pure acrylic polymer specially formulated for use with GRC.

MEDIUM/COARSE FINISHES

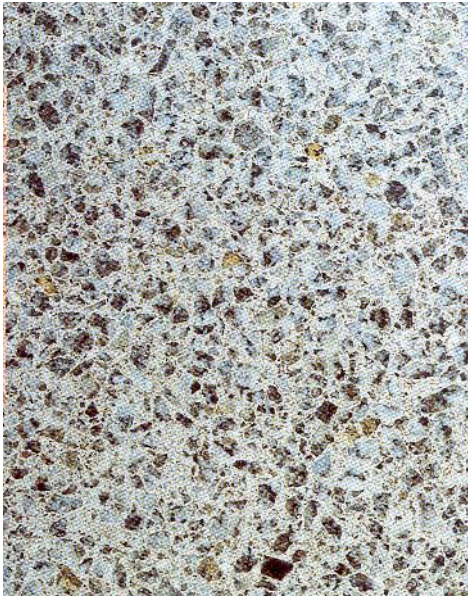

Retarded
Finish



Sand
Blasted



Polished

These finishes are similar to those that can be obtained with precast concrete and are often referred to as Exposed Aggregate. It is possible to produce GRC panels that will match precast ones and often extensions to buildings use GRC panels particularly when there are loading restrictions.

A facing layer containing cement, sand, aggregate and water, and sometimes pigment is placed into the mould. It is normally compacted by vibration using either a vibrating table or a

vibrating screed bar. The thickness of the facing layer is generally 1.5 times the diameter of the largest aggregate. Thus the following thickness would be required:

Aggregate size.	Thickness of facing layer
6	9
10	15
20	30

As the thickness of the facing layer should be as thin as possible to reduce the risk of bowing caused by differential shrinkage it would be best to limit the maximum aggregate size to 10 mm.

Once the facing layer has been placed the GRC backing can be sprayed in the normal way. Although this method of production gives excellent results on flat panels, complex shapes and returns are difficult to form and should be avoided if at all possible.

EQUIPMENT - Vibrating table or Vibrating screed bar.

Note - if a Vibrating table is used it must be large enough to support the mould which may be 3-4 metres long.



Vibrating
Screed bar

Vibrating Trowel

Materials

- Aggregates Granites, Quartz, Dolomite etc, 6-10 mm
- Pigments Iron oxide type
- Acid Hydrochloric Acid

PRODUCING THE REQUIRED TEXTURE.

When the panel is demoulded it will have the same texture as the mould, normally smooth. There are several methods of achieving the required texture.

1. Sand blasting - this is a widely used technique and once an operative has become skilled consistent results can be obtained. Sand Blasting should be carried out one or two days after demoulding. Certain aggregates lose their colour when sand blasted and these should not be used. After sand blasting a light acid etch is often given to clean the panel.
2. Acid etching - this technique can be used to give a light 'stone' texture. The acid should always be diluted before use and the panel should be wet, acid should not be applied to a dry panel. GRC has a high cement content when compared to concrete and this makes acid etching more difficult after, applying the acid it is necessary to scrub vigorously to achieve the required texture. There are Health and safety implications to consider when using acid and environmental ones when disposing of waste acid.
3. Surface retarders - with the availability of high quality surface retarders this method has become very popular in Europe. The retarder is applied to the mould prior to the start of production. It is normally applied by spray or brush. The panel is then produced as normal, but after demoulding the aggregate is exposed by simple water washing.
The retarder is supplied in a number of different grades and each grade gives a different depth of etch. Each grade is colour coded for ease of use.
4. Polishes/Ground Finishes - Both the previous finishes described can be polished. The equipment used is the same as that used for polishing marble or granite. The panel is allowed to cure for 7 days and is then ground/polished using progressively finer grinding discs. It is normally necessary to fill any holes between grinding operations.
If 10 mm aggregate was used in the facing 3 mm should be ground away, thus revealing the aggregate. If a sprayed facing with 1-2 mm aggregate was used then 0.5 mm should be removed.
Concrete will not retain a high polish like granite or marble and although the finish will be smooth it will tend to be duller in appearance than polished natural stone.
5. Textured Moulds or Mould Liners.
Textured Moulds made from rubber or GRP can be used to produce textured products. It may still be necessary to acid wash to remove any surface laitance.



Grinding to produce
a polished finish

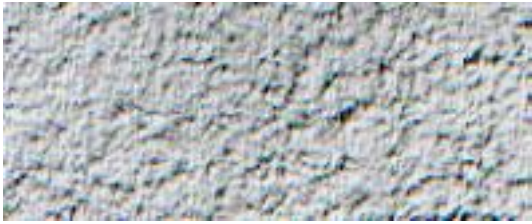

Textured Mould Liners

Fibre Technologies staff have experience in producing many different textures and finishes and can provide, training, advice, equipment and materials.

CHOICE OF FIBRE
NEG ALKALI RESISTANT GLASS FIBRES

All NEG ARG fibres are manufactured using the same glass composition with a zirconia content of 19% the highest of any commercially available glass fibre. The fibre is originally produced as 14 or 18 micron diameter filaments and these filaments are gathered together to form strands. A coating or size is used to bind the filaments together. The number of filaments forming the strand and the type of size can be varied to produce a range of glass fibres tailored to suit particular applications.

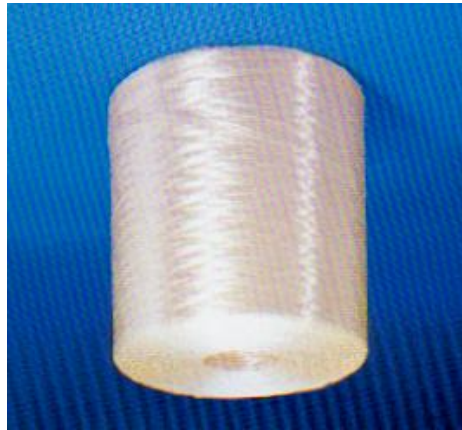

Continuous Roving

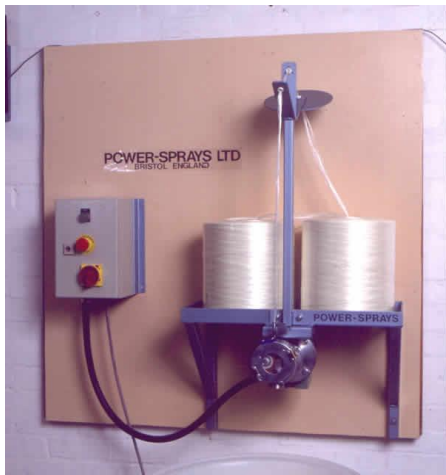

Cutting Rovings
for use in Premix



Hand Spray
using roving

ROVINGS

Rovings are used in the spray process and for premix using a single or multi roving fibre chopper.

Continuous roving is made by gathering 100 to 200 ARG fibre filaments into a strand and then winding 30 to 70 strands to form a cylindrical package.

Rovings are labelled in the following way:

A R 2500 H200

A	→	Alkali Resistant
R	→	Roving
2500	→	Roving Tex - Weight in grams of 1000m of roving.
H200	→	Sizing

Where a letter **X**, **Y**, appears at the end this indicates the number of filaments making up one strand. If there is no letter then this indicates 200 filaments per strand.

$$X = 200 \qquad Y = 100$$

The common roving types are:

AR2500H103 Often abbreviated to H 103. A relatively soft sizing makes this fibre ideal for most hand-spray operations. It is the only fibre many hand-spray manufacturers ever use. It is ideal for architectural products being easy to roll and compact in corners and complex shapes. It is not suitable for premix but because of the nature of the size the strands rapidly disperse into filaments in a concrete mixer making it an ideal crack control fibre.

AR2500H200 Often abbreviated to H200 a stiffer fibre used for flat products often produced by auto spray systems. Because of its stiffness it can be also used in premix.

AR5000H530X A roving used in premix manufacture. It can be either chopped directly into the mixer using a multi roving chopping system or pre cut and added to the mixer manually.
Because roving has almost half the packed volume of chopped strands it is cheaper to transport and store.

AR2500H350Y A roving used for either spray or premix. As the letter Y indicates it is a 100 filament per strand fibre. This gives twice as many reinforcing strands as conventional X or 200 filament fibres and tests have shown it can be used effectively at lower fibre contents. For spray it is often used at 3.5% for products like permanent formwork which only have short term loading requirements. For premix it is used at 1.5 - 2.5%.

AR5000H350Y A higher Tex version of AR2500H350Y

CHOPPED STRANDS



NEG fibres can also be supplied as chopped strands, which are produced by cutting bundled strand to the correct length.

Chopped strands are labelled:

A CS 13 H 530 X

- A** → Alkali Resistant
- CS** → Chopped Strand
- 13** → Length in mms
- H530** → Type of size:
 - H** → indicates a high integrity size used in most GRC_applications
 - S** → indicates a dispersible size used in applications where individual strands are preferred.
- X** → Number of filaments per strand: **X** = 200, **Y** = 100

The common premix fibres are:

- ACS13H530X** Chopped fibre 13mm long used for general premix applications at 2.5 - 4.0%.
- ACS13H350Y** Chopped fibre 13mm long. Very effective at lower fibre percentages. 1.5-3.0%
- ACS9H350Y** Chopped fibre 9mm long used in premix , fibre reinforced cement renders and pre-cast concrete.
- ACS13PH901X** Chopped fibres 13mm long made from 200 no 18 micron diameter filaments. Used when a high fibre percentage is required. The most suitable fibre for sprayed premix production

NETS



Nets are used to provide additional localised reinforcement for both sprayed and premix products.

Available Nets are

CODE	WEIGHT g/m²	WIDTH m.	LENGTH m
TD 5x5	145	1	100,300

QUALITY CERTIFICATE

INV-NO. : U 0 7 K 1 8 7 C T

CODE NAME: N E G A R G F I B E R
 A C S 1 3 P H - 9 0 1 X (2 0) / V

LOT-NO. : 2 0 0 7 0 7 0 2

DATE : A u g . 1 0 1 / 2 0 0 7

ITEMS OF PROPERTIES	UNT	RESULT OF TEST
FILAMENT DIAMETER	μ m	1 7 . 9
STRAND LENGTH	mm	1 3 . 6
MOISTURE CONTENT	%	0 . 0 5
ZRO2 CONTENT	%	1 9 . 1

We hereby certify that this glass fiber has the properties described herein

Katsuhiko Imai



Manager
Quality Assurance Group
Technical Department
Glass Fiber Division, Production
Nippon Electric Glass Co., Ltd.

906, IMA, HIGASHIOMI, SHIGA 521-1295, JAPAN. PHONE:0748-42-2255



QUALITY CERTIFICATE

INV-NO. : U 0 7 K 1 1 2 C T

CODE NAME: N E G A R G F I B E R
A R 2 5 0 0 H - 1 0 3 / D B

LOT-NO. : 2 0 0 7 0 4 0 6

DATE : A p 1 . / 2 7 / 2 0 0 7

ITEMS OF PROPERTIES	UNT	RESULT OF TEST
TEX COUNT	t e x	2 5 2 3
MOISTURE CONTENT	%	0 . 1 1
TENSILE STRENGTH	N / t e x	0 . 3 8 1
ZRO2 CONTENT	%	1 9 . 0

We hereby certify that this glass fiber has the properties described herein

Katsuhiko Imai

K. Imai

Manager
Quality Assurance Group
Technical Department
Glass Fiber Division, Production
Nippon Electric Glass Co., Ltd.

906, IMA, HIGASHIOMI, SHIGA 521-1295, JAPAN. PHONE:0748-42-2255